

Report No.: 18360RC40003801

Test Report

Client Name : **Anker Innovations Limited**

Client Address : **Room1318-19,Hollywood Plaza,610 Nathan Road,Mongkok,Kowloon,Hongkong**

Product Name : **Anker SOLIX Solarbank 2 E1600 Pro**

Report Date : **2024.04.24**



Shenzhen Anbotek Compliance Laboratory Limited

Shenzhen Anbotek Compliance Laboratory Limited

Address: East of 4/F., Building A, Hourui No.3 Industrial Zone, Xixiang Street, Bao'an District, Shenzhen, Guangdong, China
Tel: (86) 0755-26066126 Fax: (86) 0755-26066021 Email: service@anbotek.com

 Hotline
400-003-0500
www.anbotek.com.cn



Test Report

Report No.: 18360RC40003801

Page 1 of 135

Applicant : Anker Innovations Limited
Address : Room1318-19,Hollywood Plaza,610 Nathan Road,Mongkok,Kowloon,
Hongkong

The submitted sample and sample information was/were submitted and identified by/on the behalf of the client

Sample Name : Anker SOLIX Solarbank 2 E1600 Pro
Test Model No. : A17C1
Trade Mark : Anker
Sample Received Date : 2024.03.12; 2024.04.13
Testing Period : 2024.03.12~2024.03.22; 2024.04.13~2024.04.17

Test Requested : As specified by client, to test the Lead(Pb), Cadmium(Cd), Mercury(Hg), Hexavalent Chromium(Cr(VI)), Polybrominated Biphenyl(PBBs), Polybrominated Diphenyl Ethers (PBDEs), Diisobutyl phthalate (DIBP), Dibutyl phthalate(DBP), Benzyl butyl phthalate(BBP), Di-2-ethylhexyl phthalate(DEHP) in the selected material of the submitted sample in accordance with the RoHS Directive 2011/65/EU and amendment Commission Delegated Directive (EU) 2015/863 with effective from 22 July 2019.

Test Method: Please refer to the following page(s).

Test Result(s): Please refer to the following page(s).

Edited by Wei Jia Xin Reviewed by zoe zheng Authorized Signatory Jian



Test Report

Report No.: 18360RC40003801

Page 2 of 135

Test Method:

A. XRF Screening Test

XRF screening limits in mg/kg for regulated elements according to IEC 62321-3-1:2013.

Element	Limit of IEC 62321-3-1:2013 Unit (mg/kg)		
	Polymers	Metals	Composite material
Cd	$BL \leq (70-3\sigma) < X < (130+3\sigma) \leq OL$	$BL \leq (70-3\sigma) < X < (130+3\sigma) \leq OL$	$LOD < X < (150+3\sigma) \leq OL$
Pb	$BL \leq (700-3\sigma) < X < (1300+3\sigma) \leq OL$	$BL \leq (700-3\sigma) < X < (1300+3\sigma) \leq OL$	$BL \leq (500-3\sigma) < X < (1500+3\sigma) \leq OL$
Hg	$BL \leq (700-3\sigma) < X < (1300+3\sigma) \leq OL$	$BL \leq (700-3\sigma) < X < (1300+3\sigma) \leq OL$	$BL \leq (500-3\sigma) < X < (1500+3\sigma) \leq OL$
Br	$BL \leq (300-3\sigma) < X$	N.A.	$BL \leq (250-3\sigma) < X$
Cr	$BL \leq (700-3\sigma) < X$	$BL \leq (700-3\sigma) < X$	$BL \leq (500-3\sigma) < X$

Note:

- N.A. = Not Applicable
- BL = Under the XRF screening limit
- OL = Further chemical test will be conducted while result is above the screening limit
- X= The symbol "X" marks the region where further investigation is necessary
- 3σ= The reproducibility of analytical instruments
- LOD= Detection limit

B. Chemical Test

Test Item(s)	Test Method	Measured Equipment(s)	MDL	Limit
Lead (Pb)	IEC 62321-5:2013	ICP-OES	2 mg/kg	1000 mg/kg
Cadmium (Cd)	IEC 62321-5:2013		2 mg/kg	100 mg/kg
Mercury (Hg)	IEC 62321-4:2013+AMD1:2017		2 mg/kg	1000 mg/kg
Hexavalent Chromium Cr(VI)	IEC 62321-7-1:2015	UV-VIS	0.10µg/cm ²	---
	IEC 62321-7-2:2017		8 mg/kg	1000 mg/kg
Polybrominated Biphenyls (PBBs)	IEC 62321-6:2015	GC-MS	5 mg/kg	1000 mg/kg
Polybrominated Diphenyl Ethers (PBDEs)	IEC 62321-6:2015		5 mg/kg	1000 mg/kg
Phthalates (DIBP, DBP, BBP, DEHP)	IEC 62321-8:2017		50 mg/kg	1000 mg/kg



Test Report

Report No.: 18360RC40003801

Page 3 of 135

Test Results:

Sample No.	Sample Description	Tested Items	XRF Screening Test Unit (mg/kg)	Chemical Test Unit (mg/kg)	Conclusion
1	Metal shell with gray coating	Pb	BL	/	PASS
		Cd	BL	/	
		Hg	BL	/	
		Cr(Cr(VI))	BL	/	
		Br(PBBs&PBDEs)	N.A.	/	
		DBP	N.A.	/	
		BBP	N.A.	/	
		DEHP	N.A.	/	
2	Silvery metal sheet	Pb	BL	/	PASS
		Cd	BL	/	
		Hg	BL	/	
		Cr(Cr(VI))	BL	/	
		Br(PBBs&PBDEs)	N.A.	/	
		DBP	N.A.	/	
		BBP	N.A.	/	
		DEHP	N.A.	/	
3	Black rubber foot pad	Pb	BL	/	PASS
		Cd	BL	/	
		Hg	BL	/	
		Cr(Cr(VI))	BL	/	
		Br(PBBs&PBDEs)	BL	/	
		DBP	N.A.	N.D.	
		BBP	N.A.	N.D.	
		DEHP	N.A.	N.D.	
DIBP	N.A.	N.D.			



Test Report

Report No.: 18360RC40003801

Page 4 of 135

Sample No.	Sample Description	Tested Items	XRF Screening Test Unit (mg/kg)	Chemical Test Unit (mg/kg)	Conclusion
4	Black rubber sheet	Pb	BL	/	PASS
		Cd	BL	/	
		Hg	BL	/	
		Cr(Cr(VI))	BL	/	
		Br(PBBs&PBDEs)	BL	/	
		DBP	N.A.	N.D.	
		BBP	N.A.	N.D.	
		DEHP	N.A.	N.D.	
5	Red rubber ring	Pb	BL	/	PASS
		Cd	BL	/	
		Hg	BL	/	
		Cr(Cr(VI))	BL	/	
		Br(PBBs&PBDEs)	BL	/	
		DBP	N.A.	N.D.	
		BBP	N.A.	N.D.	
		DEHP	N.A.	N.D.	
6	Black plastic shell	Pb	BL	/	PASS
		Cd	BL	/	
		Hg	BL	/	
		Cr(Cr(VI))	BL	/	
		Br(PBBs&PBDEs)	X	N.D.	
		DBP	N.A.	N.D.	
		BBP	N.A.	N.D.	
		DEHP	N.A.	N.D.	
DIBP	N.A.	N.D.			



Test Report

Report No.: 18360RC40003801

Page 5 of 135

Sample No.	Sample Description	Tested Items	XRF Screening Test Unit (mg/kg)	Chemical Test Unit (mg/kg)	Conclusion
7	Red rubber ring	Pb	BL	/	PASS
		Cd	BL	/	
		Hg	BL	/	
		Cr(Cr(VI))	BL	/	
		Br(PBBs&PBDEs)	BL	/	
		DBP	N.A.	N.D.	
		BBP	N.A.	N.D.	
		DEHP	N.A.	N.D.	
8	Silvery metal contact pin	Pb	OL	32149*	PASS
		Cd	BL	/	
		Hg	BL	/	
		Cr(Cr(VI))	BL	/	
		Br(PBBs&PBDEs)	N.A.	/	
		DBP	N.A.	/	
		BBP	N.A.	/	
		DEHP	N.A.	/	
9	White heat thermal shrinkable sleeve	Pb	BL	/	PASS
		Cd	BL	/	
		Hg	BL	/	
		Cr(Cr(VI))	BL	/	
		Br(PBBs&PBDEs)	BL	/	
		DBP	N.A.	N.D.	
		BBP	N.A.	N.D.	
		DEHP	N.A.	N.D.	
DIBP	N.A.	N.D.			



Test Report

Report No.: 18360RC40003801

Page 6 of 135

Sample No.	Sample Description	Tested Items	XRF Screening Test Unit (mg/kg)	Chemical Test Unit (mg/kg)	Conclusion
10	Black plastic jacket	Pb	BL	/	PASS
		Cd	BL	/	
		Hg	BL	/	
		Cr(Cr(VI))	BL	/	
		Br(PBBs&PBDEs)	BL	/	
		DBP	N.A.	N.D.	
		BBP	N.A.	N.D.	
		DEHP	N.A.	N.D.	
11	Yellow plastic jacket	Pb	BL	/	PASS
		Cd	BL	/	
		Hg	BL	/	
		Cr(Cr(VI))	BL	/	
		Br(PBBs&PBDEs)	BL	/	
		DBP	N.A.	N.D.	
		BBP	N.A.	N.D.	
		DEHP	N.A.	N.D.	
12	Red plastic jacket	Pb	BL	/	PASS
		Cd	BL	/	
		Hg	BL	/	
		Cr(Cr(VI))	BL	/	
		Br(PBBs&PBDEs)	BL	/	
		DBP	N.A.	N.D.	
		BBP	N.A.	N.D.	
		DEHP	N.A.	N.D.	
DIBP	N.A.	N.D.			



Test Report

Report No.: 18360RC40003801

Page 7 of 135

Sample No.	Sample Description	Tested Items	XRF Screening Test Unit (mg/kg)	Chemical Test Unit (mg/kg)	Conclusion
13	Black heat thermal shrinkable sleeve	Pb	BL	/	PASS
		Cd	BL	/	
		Hg	BL	/	
		Cr(Cr(VI))	BL	/	
		Br(PBBs&PBDEs)	BL	/	
		DBP	N.A.	N.D.	
		BBP	N.A.	N.D.	
		DEHP	N.A.	N.D.	
14	Black rubber sheet	Pb	BL	/	PASS
		Cd	BL	/	
		Hg	BL	/	
		Cr(Cr(VI))	BL	/	
		Br(PBBs&PBDEs)	BL	/	
		DBP	N.A.	N.D.	
		BBP	N.A.	N.D.	
		DEHP	N.A.	N.D.	
15	Black plastic jacket	Pb	BL	/	PASS
		Cd	BL	/	
		Hg	BL	/	
		Cr(Cr(VI))	BL	/	
		Br(PBBs&PBDEs)	BL	/	
		DBP	N.A.	N.D.	
		BBP	N.A.	N.D.	
		DEHP	N.A.	N.D.	
DIBP	N.A.	N.D.			



Test Report

Report No.: 18360RC40003801

Page 8 of 135

Sample No.	Sample Description	Tested Items	XRF Screening Test Unit (mg/kg)	Chemical Test Unit (mg/kg)	Conclusion
16	Black rubber sheet	Pb	BL	/	PASS
		Cd	BL	/	
		Hg	BL	/	
		Cr(Cr(VI))	BL	/	
		Br(PBBs&PBDEs)	BL	/	
		DBP	N.A.	N.D.	
		BBP	N.A.	N.D.	
		DEHP	N.A.	N.D.	
17	Red plastic jacket	Pb	BL	/	PASS
		Cd	BL	/	
		Hg	BL	/	
		Cr(Cr(VI))	BL	/	
		Br(PBBs&PBDEs)	BL	/	
		DBP	N.A.	N.D.	
		BBP	N.A.	N.D.	
		DEHP	N.A.	N.D.	
18	Black plastic shell	Pb	BL	/	PASS
		Cd	BL	/	
		Hg	BL	/	
		Cr(Cr(VI))	BL	/	
		Br(PBBs&PBDEs)	X	N.D.	
		DBP	N.A.	N.D.	
		BBP	N.A.	N.D.	
		DEHP	N.A.	N.D.	
DIBP	N.A.	N.D.			



Test Report

Report No.: 18360RC40003801

Page 9 of 135

Sample No.	Sample Description	Tested Items	XRF Screening Test Unit (mg/kg)	Chemical Test Unit (mg/kg)	Conclusion
19	Green yellow plastic jacket	Pb	BL	/	PASS
		Cd	BL	/	
		Hg	BL	/	
		Cr(Cr(VI))	BL	/	
		Br(PBBs&PBDEs)	BL	/	
		DBP	N.A.	N.D.	
		BBP	N.A.	N.D.	
		DEHP	N.A.	N.D.	
20	Red plastic jacket	Pb	BL	/	PASS
		Cd	BL	/	
		Hg	BL	/	
		Cr(Cr(VI))	BL	/	
		Br(PBBs&PBDEs)	BL	/	
		DBP	N.A.	N.D.	
		BBP	N.A.	N.D.	
		DEHP	N.A.	N.D.	
21	Brown plastic jacket	Pb	BL	/	PASS
		Cd	BL	/	
		Hg	BL	/	
		Cr(Cr(VI))	BL	/	
		Br(PBBs&PBDEs)	BL	/	
		DBP	N.A.	N.D.	
		BBP	N.A.	N.D.	
		DEHP	N.A.	N.D.	
DIBP	N.A.	N.D.			



Test Report

Report No.: 18360RC40003801

Page 10 of 135

Sample No.	Sample Description	Tested Items	XRF Screening Test Unit (mg/kg)	Chemical Test Unit (mg/kg)	Conclusion
22	Purple plastic jacket	Pb	BL	/	PASS
		Cd	BL	/	
		Hg	BL	/	
		Cr(Cr(VI))	BL	/	
		Br(PBBs&PBDEs)	BL	/	
		DBP	N.A.	N.D.	
		BBP	N.A.	N.D.	
		DEHP	N.A.	N.D.	
23	Black plastic jacket	Pb	BL	/	PASS
		Cd	BL	/	
		Hg	BL	/	
		Cr(Cr(VI))	BL	/	
		Br(PBBs&PBDEs)	BL	/	
		DBP	N.A.	N.D.	
		BBP	N.A.	N.D.	
		DEHP	N.A.	N.D.	
24	White heat thermal shrinkable sleeve	Pb	BL	/	PASS
		Cd	BL	/	
		Hg	BL	/	
		Cr(Cr(VI))	BL	/	
		Br(PBBs&PBDEs)	BL	/	
		DBP	N.A.	N.D.	
		BBP	N.A.	N.D.	
		DEHP	N.A.	N.D.	
DIBP	N.A.	N.D.			



Test Report

Report No.: 18360RC40003801

Page 11 of 135

Sample No.	Sample Description	Tested Items	XRF Screening Test Unit (mg/kg)	Chemical Test Unit (mg/kg)	Conclusion
25	White fiberglass tube	Pb	BL	/	PASS
		Cd	BL	/	
		Hg	BL	/	
		Cr(Cr(VI))	BL	/	
		Br(PBBs&PBDEs)	BL	/	
		DBP	N.A.	N.D.	
		BBP	N.A.	N.D.	
		DEHP	N.A.	N.D.	
26	Red plastic jacket	Pb	BL	/	PASS
		Cd	BL	/	
		Hg	BL	/	
		Cr(Cr(VI))	BL	/	
		Br(PBBs&PBDEs)	BL	/	
		DBP	N.A.	N.D.	
		BBP	N.A.	N.D.	
		DEHP	N.A.	N.D.	
27	Black plastic sheet	Pb	BL	/	PASS
		Cd	BL	/	
		Hg	BL	/	
		Cr(Cr(VI))	BL	/	
		Br(PBBs&PBDEs)	X	N.D.	
		DBP	N.A.	N.D.	
		BBP	N.A.	N.D.	
		DEHP	N.A.	N.D.	
DIBP	N.A.	N.D.			



Test Report

Report No.: 18360RC40003801

Page 12 of 135

Sample No.	Sample Description	Tested Items	XRF Screening Test Unit (mg/kg)	Chemical Test Unit (mg/kg)	Conclusion
28	Silvery metal spring	Pb	BL	/	PASS
		Cd	BL	/	
		Hg	BL	/	
		Cr(Cr(VI))	BL	/	
		Br(PBBs&PBDEs)	N.A.	/	
		DBP	N.A.	/	
		BBP	N.A.	/	
		DEHP	N.A.	/	
29	Black heat thermal shrinkable sleeve	Pb	BL	/	PASS
		Cd	BL	/	
		Hg	BL	/	
		Cr(Cr(VI))	BL	/	
		Br(PBBs&PBDEs)	BL	/	
		DBP	N.A.	N.D.	
		BBP	N.A.	N.D.	
		DEHP	N.A.	N.D.	
30	Silvery metal sheet	Pb	BL	/	PASS
		Cd	BL	/	
		Hg	BL	/	
		Cr(Cr(VI))	BL	/	
		Br(PBBs&PBDEs)	N.A.	/	
		DBP	N.A.	/	
		BBP	N.A.	/	
		DEHP	N.A.	/	
DIBP	N.A.	/			



Test Report

Report No.: 18360RC40003801

Page 13 of 135

Sample No.	Sample Description	Tested Items	XRF Screening Test Unit (mg/kg)	Chemical Test Unit (mg/kg)	Conclusion
31	Silvery metal block	Pb	BL	/	PASS
		Cd	BL	/	
		Hg	BL	/	
		Cr(Cr(VI))	BL	/	
		Br(PBBs&PBDEs)	N.A.	/	
		DBP	N.A.	/	
		BBP	N.A.	/	
		DEHP	N.A.	/	
32	Silvery metal insert	Pb	BL	/	PASS
		Cd	BL	/	
		Hg	BL	/	
		Cr(Cr(VI))	BL	/	
		Br(PBBs&PBDEs)	N.A.	/	
		DBP	N.A.	/	
		BBP	N.A.	/	
		DEHP	N.A.	/	
33	Translucent rubber sheath	Pb	BL	/	PASS
		Cd	BL	/	
		Hg	BL	/	
		Cr(Cr(VI))	BL	/	
		Br(PBBs&PBDEs)	BL	/	
		DBP	N.A.	N.D.	
		BBP	N.A.	N.D.	
		DEHP	N.A.	N.D.	
DIBP	N.A.	N.D.			



Test Report

Report No.: 18360RC40003801

Page 14 of 135

Sample No.	Sample Description	Tested Items	XRF Screening Test Unit (mg/kg)	Chemical Test Unit (mg/kg)	Conclusion
34	Black plastic jacket	Pb	BL	/	PASS
		Cd	BL	/	
		Hg	BL	/	
		Cr(Cr(VI))	BL	/	
		Br(PBBs&PBDEs)	BL	/	
		DBP	N.A.	N.D.	
		BBP	N.A.	N.D.	
		DEHP	N.A.	N.D.	
35	Red plastic jacket	Pb	BL	/	PASS
		Cd	BL	/	
		Hg	BL	/	
		Cr(Cr(VI))	BL	/	
		Br(PBBs&PBDEs)	BL	/	
		DBP	N.A.	N.D.	
		BBP	N.A.	N.D.	
		DEHP	N.A.	N.D.	
36	White heat thermal shrinkable sleeve	Pb	BL	/	PASS
		Cd	BL	/	
		Hg	BL	/	
		Cr(Cr(VI))	BL	/	
		Br(PBBs&PBDEs)	BL	/	
		DBP	N.A.	N.D.	
		BBP	N.A.	N.D.	
		DEHP	N.A.	N.D.	
DIBP	N.A.	N.D.			



Test Report

Report No.: 18360RC40003801

Page 15 of 135

Sample No.	Sample Description	Tested Items	XRF Screening Test Unit (mg/kg)	Chemical Test Unit (mg/kg)	Conclusion
37	White glue	Pb	BL	/	PASS
		Cd	BL	/	
		Hg	BL	/	
		Cr(Cr(VI))	BL	/	
		Br(PBBs&PBDEs)	BL	/	
		DBP	N.A.	N.D.	
		BBP	N.A.	N.D.	
		DEHP	N.A.	N.D.	
38	Blue capacitor	Pb	BL	/	PASS
		Cd	BL	/	
		Hg	BL	/	
		Cr(Cr(VI))	BL	/	
		Br(PBBs&PBDEs)	BL	/	
		DBP	N.A.	N.D.	
		BBP	N.A.	N.D.	
		DEHP	N.A.	N.D.	
39	Green PCB board	Pb	BL	/	PASS
		Cd	BL	/	
		Hg	BL	/	
		Cr(Cr(VI))	BL	/	
		Br(PBBs&PBDEs)	X	N.D.	
		DBP	N.A.	N.D.	
		BBP	N.A.	N.D.	
		DEHP	N.A.	N.D.	
DIBP	N.A.	N.D.			



Test Report

Report No.: 18360RC40003801

Page 16 of 135

Sample No.	Sample Description	Tested Items	XRF Screening Test Unit (mg/kg)	Chemical Test Unit (mg/kg)	Conclusion
40	Copper-colored metal socket	Pb	OL	28946*	PASS
		Cd	BL	/	
		Hg	BL	/	
		Cr(Cr(VI))	BL	/	
		Br(PBBs&PBDEs)	N.A.	/	
		DBP	N.A.	/	
		BBP	N.A.	/	
		DEHP	N.A.	/	
41	Copper-colored metal socket	Pb	OL	27137*	PASS
		Cd	BL	/	
		Hg	BL	/	
		Cr(Cr(VI))	BL	/	
		Br(PBBs&PBDEs)	N.A.	/	
		DBP	N.A.	/	
		BBP	N.A.	/	
		DEHP	N.A.	/	
42	Translucent rubber ring	Pb	BL	/	PASS
		Cd	BL	/	
		Hg	BL	/	
		Cr(Cr(VI))	BL	/	
		Br(PBBs&PBDEs)	BL	/	
		DBP	N.A.	N.D.	
		BBP	N.A.	N.D.	
		DEHP	N.A.	N.D.	
DIBP	N.A.	N.D.			



Test Report

Report No.: 18360RC40003801

Page 17 of 135

Sample No.	Sample Description	Tested Items	XRF Screening Test Unit (mg/kg)	Chemical Test Unit (mg/kg)	Conclusion
43	Silvery metal socket	Pb	BL	/	PASS
		Cd	BL	/	
		Hg	BL	/	
		Cr(Cr(VI))	BL	/	
		Br(PBBs&PBDEs)	N.A.	/	
		DBP	N.A.	/	
		BBP	N.A.	/	
		DEHP	N.A.	/	
44	Black plastic shell	Pb	BL	/	PASS
		Cd	BL	/	
		Hg	BL	/	
		Cr(Cr(VI))	BL	/	
		Br(PBBs&PBDEs)	BL	/	
		DBP	N.A.	N.D.	
		BBP	N.A.	N.D.	
		DEHP	N.A.	N.D.	
45	White rubber sheet	Pb	BL	/	PASS
		Cd	BL	/	
		Hg	BL	/	
		Cr(Cr(VI))	BL	/	
		Br(PBBs&PBDEs)	BL	/	
		DBP	N.A.	N.D.	
		BBP	N.A.	N.D.	
		DEHP	N.A.	N.D.	
DIBP	N.A.	N.D.			



Test Report

Report No.: 18360RC40003801

Page 18 of 135

Sample No.	Sample Description	Tested Items	XRF Screening Test Unit (mg/kg)	Chemical Test Unit (mg/kg)	Conclusion
46	Black plastic shell	Pb	BL	/	PASS
		Cd	BL	/	
		Hg	BL	/	
		Cr(Cr(VI))	BL	/	
		Br(PBBs&PBDEs)	BL	/	
		DBP	N.A.	N.D.	
		BBP	N.A.	N.D.	
		DEHP	N.A.	N.D.	
47	Silvery metal socket	Pb	BL	/	PASS
		Cd	BL	/	
		Hg	BL	/	
		Cr(Cr(VI))	BL	/	
		Br(PBBs&PBDEs)	N.A.	/	
		DBP	N.A.	/	
		BBP	N.A.	/	
		DEHP	N.A.	/	
48	Red rubber ring	Pb	BL	/	PASS
		Cd	BL	/	
		Hg	BL	/	
		Cr(Cr(VI))	BL	/	
		Br(PBBs&PBDEs)	BL	/	
		DBP	N.A.	N.D.	
		BBP	N.A.	N.D.	
		DEHP	N.A.	N.D.	
		DIBP	N.A.	N.D.	



Test Report

Report No.: 18360RC40003801

Page 19 of 135

Sample No.	Sample Description	Tested Items	XRF Screening Test Unit (mg/kg)	Chemical Test Unit (mg/kg)	Conclusion
49	Black plastic shell	Pb	BL	/	PASS
		Cd	BL	/	
		Hg	BL	/	
		Cr(Cr(VI))	BL	/	
		Br(PBBs&PBDEs)	BL	/	
		DBP	N.A.	N.D.	
		BBP	N.A.	N.D.	
		DEHP	N.A.	N.D.	
50	Black plastic wire sleeve	Pb	BL	/	PASS
		Cd	BL	/	
		Hg	BL	/	
		Cr(Cr(VI))	BL	/	
		Br(PBBs&PBDEs)	BL	/	
		DBP	N.A.	N.D.	
		BBP	N.A.	N.D.	
		DEHP	N.A.	N.D.	
51	Black plastic block	Pb	BL	/	PASS
		Cd	BL	/	
		Hg	BL	/	
		Cr(Cr(VI))	BL	/	
		Br(PBBs&PBDEs)	X	N.D.	
		DBP	N.A.	N.D.	
		BBP	N.A.	N.D.	
		DEHP	N.A.	N.D.	
DIBP	N.A.	N.D.			



Test Report

Report No.: 18360RC40003801

Page 20 of 135

Sample No.	Sample Description	Tested Items	XRF Screening Test Unit (mg/kg)	Chemical Test Unit (mg/kg)	Conclusion
52	Black plastic sheet	Pb	BL	/	PASS
		Cd	BL	/	
		Hg	BL	/	
		Cr(Cr(VI))	BL	/	
		Br(PBBs&PBDEs)	BL	/	
		DBP	N.A.	N.D.	
		BBP	N.A.	N.D.	
		DEHP	N.A.	N.D.	
		DIBP	N.A.	N.D.	
53	Black plastic sheet	Pb	BL	/	PASS
		Cd	BL	/	
		Hg	BL	/	
		Cr(Cr(VI))	BL	/	
		Br(PBBs&PBDEs)	BL	/	
		DBP	N.A.	N.D.	
		BBP	N.A.	N.D.	
		DEHP	N.A.	N.D.	
		DIBP	N.A.	N.D.	
54	Silvery metal sheet	Pb	BL	/	PASS
		Cd	BL	/	
		Hg	BL	/	
		Cr(Cr(VI))	BL	/	
		Br(PBBs&PBDEs)	N.A.	/	
		DBP	N.A.	/	
		BBP	N.A.	/	
		DEHP	N.A.	/	
		DIBP	N.A.	/	



Test Report

Report No.: 18360RC40003801

Page 21 of 135

Sample No.	Sample Description	Tested Items	XRF Screening Test Unit (mg/kg)	Chemical Test Unit (mg/kg)	Conclusion
55	Black foam patch	Pb	BL	/	PASS
		Cd	BL	/	
		Hg	BL	/	
		Cr(Cr(VI))	BL	/	
		Br(PBBs&PBDEs)	BL	/	
		DBP	N.A.	N.D.	
		BBP	N.A.	N.D.	
		DEHP	N.A.	N.D.	
56	Black plastic sheet	Pb	BL	/	PASS
		Cd	BL	/	
		Hg	BL	/	
		Cr(Cr(VI))	BL	/	
		Br(PBBs&PBDEs)	BL	/	
		DBP	N.A.	N.D.	
		BBP	N.A.	N.D.	
		DEHP	N.A.	N.D.	
57	Black plastic sheet	Pb	BL	/	PASS
		Cd	BL	/	
		Hg	BL	/	
		Cr(Cr(VI))	BL	/	
		Br(PBBs&PBDEs)	X	N.D.	
		DBP	N.A.	N.D.	
		BBP	N.A.	N.D.	
		DEHP	N.A.	N.D.	
DIBP	N.A.	N.D.			



Test Report

Report No.: 18360RC40003801

Page 22 of 135

Sample No.	Sample Description	Tested Items	XRF Screening Test Unit (mg/kg)	Chemical Test Unit (mg/kg)	Conclusion
58	White glue	Pb	BL	/	PASS
		Cd	BL	/	
		Hg	BL	/	
		Cr(Cr(VI))	BL	/	
		Br(PBBs&PBDEs)	BL	/	
		DBP	N.A.	N.D.	
		BBP	N.A.	N.D.	
		DEHP	N.A.	N.D.	
59	Plastic sheet with black plating	Pb	BL	/	PASS
		Cd	BL	/	
		Hg	BL	/	
		Cr(Cr(VI))	BL	/	
		Br(PBBs&PBDEs)	BL	/	
		DBP	N.A.	N.D.	
		BBP	N.A.	N.D.	
		DEHP	N.A.	N.D.	
60	White label	Pb	BL	/	PASS
		Cd	BL	/	
		Hg	BL	/	
		Cr(Cr(VI))	BL	/	
		Br(PBBs&PBDEs)	BL	/	
		DBP	N.A.	N.D.	
		BBP	N.A.	167	
		DEHP	N.A.	N.D.	
DIBP	N.A.	N.D.			



Test Report

Report No.: 18360RC40003801

Page 23 of 135

Sample No.	Sample Description	Tested Items	XRF Screening Test Unit (mg/kg)	Chemical Test Unit (mg/kg)	Conclusion
61	Silvery metal soldering tin	Pb	BL	/	PASS
		Cd	BL	/	
		Hg	BL	/	
		Cr(Cr(VI))	BL	/	
		Br(PBBs&PBDEs)	N.A.	/	
		DBP	N.A.	/	
		BBP	N.A.	/	
		DEHP	N.A.	/	
62	Silvery metal cable core	Pb	BL	/	PASS
		Cd	BL	/	
		Hg	BL	/	
		Cr(Cr(VI))	BL	/	
		Br(PBBs&PBDEs)	N.A.	/	
		DBP	N.A.	/	
		BBP	N.A.	/	
		DEHP	N.A.	/	
63	Silvery metal pin	Pb	BL	/	PASS
		Cd	BL	/	
		Hg	BL	/	
		Cr(Cr(VI))	BL	/	
		Br(PBBs&PBDEs)	N.A.	/	
		DBP	N.A.	/	
		BBP	N.A.	/	
		DEHP	N.A.	/	
		DIBP	N.A.	/	



Test Report

Report No.: 18360RC40003801

Page 24 of 135

Sample No.	Sample Description	Tested Items	XRF Screening Test Unit (mg/kg)	Chemical Test Unit (mg/kg)	Conclusion
64	White plastic terminals	Pb	BL	/	PASS
		Cd	BL	/	
		Hg	BL	/	
		Cr(Cr(VI))	BL	/	
		Br(PBBs&PBDEs)	BL	/	
		DBP	N.A.	N.D.	
		BBP	N.A.	N.D.	
		DEHP	N.A.	N.D.	
65	Red rubber sheet	Pb	BL	/	PASS
		Cd	BL	/	
		Hg	BL	/	
		Cr(Cr(VI))	BL	/	
		Br(PBBs&PBDEs)	BL	/	
		DBP	N.A.	N.D.	
		BBP	N.A.	N.D.	
		DEHP	N.A.	N.D.	
66	Black fabric cloth	Pb	BL	/	PASS
		Cd	BL	/	
		Hg	BL	/	
		Cr(Cr(VI))	BL	/	
		Br(PBBs&PBDEs)	BL	/	
		DBP	N.A.	N.D.	
		BBP	N.A.	N.D.	
		DEHP	N.A.	N.D.	
DIBP	N.A.	N.D.			



Test Report

Report No.: 18360RC40003801

Page 25 of 135

Sample No.	Sample Description	Tested Items	XRF Screening Test Unit (mg/kg)	Chemical Test Unit (mg/kg)	Conclusion
67	Red plastic jacket	Pb	BL	/	PASS
		Cd	BL	/	
		Hg	BL	/	
		Cr(Cr(VI))	BL	/	
		Br(PBBs&PBDEs)	BL	/	
		DBP	N.A.	N.D.	
		BBP	N.A.	N.D.	
		DEHP	N.A.	N.D.	
68	Red heat thermal shrinkable sleeve	Pb	BL	/	PASS
		Cd	BL	/	
		Hg	BL	/	
		Cr(Cr(VI))	BL	/	
		Br(PBBs&PBDEs)	BL	/	
		DBP	N.A.	N.D.	
		BBP	N.A.	N.D.	
		DEHP	N.A.	N.D.	
69	Silvery metal ring	Pb	BL	/	PASS
		Cd	BL	/	
		Hg	BL	/	
		Cr(Cr(VI))	BL	/	
		Br(PBBs&PBDEs)	N.A.	/	
		DBP	N.A.	/	
		BBP	N.A.	/	
		DEHP	N.A.	/	
DIBP	N.A.	/			



Test Report

Report No.: 18360RC40003801

Page 26 of 135

Sample No.	Sample Description	Tested Items	XRF Screening Test Unit (mg/kg)	Chemical Test Unit (mg/kg)	Conclusion
70	Orange yellow rubber ring	Pb	BL	/	PASS
		Cd	BL	/	
		Hg	BL	/	
		Cr(Cr(VI))	BL	/	
		Br(PBBs&PBDEs)	BL	/	
		DBP	N.A.	N.D.	
		BBP	N.A.	N.D.	
		DEHP	N.A.	N.D.	
71	Silvery metal sheet	Pb	BL	/	PASS
		Cd	BL	/	
		Hg	BL	/	
		Cr(Cr(VI))	BL	/	
		Br(PBBs&PBDEs)	N.A.	/	
		DBP	N.A.	/	
		BBP	N.A.	/	
		DEHP	N.A.	/	
72	Black plastic jacket	Pb	BL	/	PASS
		Cd	BL	/	
		Hg	BL	/	
		Cr(Cr(VI))	BL	/	
		Br(PBBs&PBDEs)	BL	/	
		DBP	N.A.	N.D.	
		BBP	N.A.	N.D.	
		DEHP	N.A.	N.D.	
DIBP	N.A.	N.D.			



Test Report

Report No.: 18360RC40003801

Page 27 of 135

Sample No.	Sample Description	Tested Items	XRF Screening Test Unit (mg/kg)	Chemical Test Unit (mg/kg)	Conclusion
73	Red plastic jacket	Pb	BL	/	PASS
		Cd	BL	/	
		Hg	BL	/	
		Cr(Cr(VI))	BL	/	
		Br(PBBs&PBDEs)	BL	/	
		DBP	N.A.	N.D.	
		BBP	N.A.	N.D.	
		DEHP	N.A.	N.D.	
74	Silvery metal screw	Pb	BL	/	PASS
		Cd	BL	/	
		Hg	BL	/	
		Cr(Cr(VI))	BL	/	
		Br(PBBs&PBDEs)	N.A.	/	
		DBP	N.A.	/	
		BBP	N.A.	/	
		DEHP	N.A.	/	
75	Green PCB board	Pb	BL	/	PASS
		Cd	BL	/	
		Hg	BL	/	
		Cr(Cr(VI))	BL	/	
		Br(PBBs&PBDEs)	X	N.D.	
		DBP	N.A.	N.D.	
		BBP	N.A.	N.D.	
		DEHP	N.A.	N.D.	
DIBP	N.A.	N.D.			



Test Report

Report No.: 18360RC40003801

Page 28 of 135

Sample No.	Sample Description	Tested Items	XRF Screening Test Unit (mg/kg)	Chemical Test Unit (mg/kg)	Conclusion
76	Grey relay	Pb	BL	/	PASS
		Cd	BL	/	
		Hg	BL	/	
		Cr(Cr(VI))	BL	/	
		Br(PBBs&PBDEs)	X	N.D.	
		DBP	N.A.	N.D.	
		BBP	N.A.	N.D.	
		DEHP	N.A.	N.D.	
77	Black plastic jacket	Pb	BL	/	PASS
		Cd	BL	/	
		Hg	BL	/	
		Cr(Cr(VI))	BL	/	
		Br(PBBs&PBDEs)	BL	/	
		DBP	N.A.	N.D.	
		BBP	N.A.	N.D.	
		DEHP	N.A.	N.D.	
78	Black heat thermal shrinkable tube	Pb	BL	/	PASS
		Cd	BL	/	
		Hg	BL	/	
		Cr(Cr(VI))	BL	/	
		Br(PBBs&PBDEs)	BL	/	
		DBP	N.A.	N.D.	
		BBP	N.A.	N.D.	
		DEHP	N.A.	162	
DIBP	N.A.	N.D.			



Test Report

Report No.: 18360RC40003801

Page 29 of 135

Sample No.	Sample Description	Tested Items	XRF Screening Test Unit (mg/kg)	Chemical Test Unit (mg/kg)	Conclusion
79	Pink silicone grease	Pb	BL	/	PASS
		Cd	BL	/	
		Hg	BL	/	
		Cr(Cr(VI))	BL	/	
		Br(PBBs&PBDEs)	BL	/	
		DBP	N.A.	N.D.	
		BBP	N.A.	N.D.	
		DEHP	N.A.	N.D.	
80	Black heat thermal shrinkable sleeve	Pb	BL	/	PASS
		Cd	BL	/	
		Hg	BL	/	
		Cr(Cr(VI))	BL	/	
		Br(PBBs&PBDEs)	BL	/	
		DBP	N.A.	N.D.	
		BBP	N.A.	N.D.	
		DEHP	N.A.	N.D.	
81	Grey silicone grease	Pb	BL	/	PASS
		Cd	BL	/	
		Hg	BL	/	
		Cr(Cr(VI))	BL	/	
		Br(PBBs&PBDEs)	BL	/	
		DBP	N.A.	N.D.	
		BBP	N.A.	N.D.	
		DEHP	N.A.	N.D.	
DIBP	N.A.	N.D.			



Test Report

Report No.: 18360RC40003801

Page 30 of 135

Sample No.	Sample Description	Tested Items	XRF Screening Test Unit (mg/kg)	Chemical Test Unit (mg/kg)	Conclusion
82	IC	Pb	BL	/	PASS
		Cd	BL	/	
		Hg	BL	/	
		Cr(Cr(VI))	BL	/	
		Br(PBBs&PBDEs)	BL	/	
		DBP	N.A.	N.D.	
		BBP	N.A.	N.D.	
		DEHP	N.A.	N.D.	
83	IC	Pb	BL	/	PASS
		Cd	BL	/	
		Hg	BL	/	
		Cr(Cr(VI))	BL	/	
		Br(PBBs&PBDEs)	BL	/	
		DBP	N.A.	N.D.	
		BBP	N.A.	N.D.	
		DEHP	N.A.	N.D.	
84	LED	Pb	BL	/	PASS
		Cd	BL	/	
		Hg	BL	/	
		Cr(Cr(VI))	BL	/	
		Br(PBBs&PBDEs)	BL	/	
		DBP	N.A.	N.D.	
		BBP	N.A.	N.D.	
		DEHP	N.A.	N.D.	
DIBP	N.A.	N.D.			



Test Report

Report No.: 18360RC40003801

Page 31 of 135

Sample No.	Sample Description	Tested Items	XRF Screening Test Unit (mg/kg)	Chemical Test Unit (mg/kg)	Conclusion
85	Silvery metal pin	Pb	BL	/	PASS
		Cd	BL	/	
		Hg	BL	/	
		Cr(Cr(VI))	BL	/	
		Br(PBBs&PBDEs)	N.A.	/	
		DBP	N.A.	/	
		BBP	N.A.	/	
		DEHP	N.A.	/	
86	Chip diode	Pb	BL	/	PASS
		Cd	BL	/	
		Hg	BL	/	
		Cr(Cr(VI))	BL	/	
		Br(PBBs&PBDEs)	BL	/	
		DBP	N.A.	N.D.	
		BBP	N.A.	N.D.	
		DEHP	N.A.	N.D.	
87	IC	Pb	BL	/	PASS
		Cd	BL	/	
		Hg	BL	/	
		Cr(Cr(VI))	BL	/	
		Br(PBBs&PBDEs)	BL	/	
		DBP	N.A.	N.D.	
		BBP	N.A.	N.D.	
		DEHP	N.A.	N.D.	
DIBP	N.A.	N.D.			



Test Report

Report No.: 18360RC40003801

Page 32 of 135

Sample No.	Sample Description	Tested Items	XRF Screening Test Unit (mg/kg)	Chemical Test Unit (mg/kg)	Conclusion
88	Grey inductor	Pb	BL	/	PASS
		Cd	BL	/	
		Hg	BL	/	
		Cr(Cr(VI))	X	N.D.	
		Br(PBBs&PBDEs)	BL	/	
		DBP	N.A.	N.D.	
		BBP	N.A.	N.D.	
		DEHP	N.A.	N.D.	
89	IC	Pb	BL	/	PASS
		Cd	BL	/	
		Hg	BL	/	
		Cr(Cr(VI))	BL	/	
		Br(PBBs&PBDEs)	BL	/	
		DBP	N.A.	N.D.	
		BBP	N.A.	N.D.	
		DEHP	N.A.	N.D.	
90	Silvery metal crystal oscillator	Pb	BL	/	PASS
		Cd	BL	/	
		Hg	BL	/	
		Cr(Cr(VI))	BL	/	
		Br(PBBs&PBDEs)	N.A.	/	
		DBP	N.A.	/	
		BBP	N.A.	/	
		DEHP	N.A.	/	
		DIBP	N.A.	/	



Test Report

Report No.: 18360RC40003801

Page 33 of 135

Sample No.	Sample Description	Tested Items	XRF Screening Test Unit (mg/kg)	Chemical Test Unit (mg/kg)	Conclusion
91	IC	Pb	BL	/	PASS
		Cd	BL	/	
		Hg	BL	/	
		Cr(Cr(VI))	BL	/	
		Br(PBBs&PBDEs)	BL	/	
		DBP	N.A.	N.D.	
		BBP	N.A.	N.D.	
		DEHP	N.A.	N.D.	
92	Chip audion	Pb	BL	/	PASS
		Cd	BL	/	
		Hg	BL	/	
		Cr(Cr(VI))	BL	/	
		Br(PBBs&PBDEs)	BL	/	
		DBP	N.A.	N.D.	
		BBP	N.A.	N.D.	
		DEHP	N.A.	N.D.	
93	Chip capacitor	Pb	BL	/	PASS
		Cd	BL	/	
		Hg	BL	/	
		Cr(Cr(VI))	BL	/	
		Br(PBBs&PBDEs)	BL	/	
		DBP	N.A.	N.D.	
		BBP	N.A.	N.D.	
		DEHP	N.A.	N.D.	
		DIBP	N.A.	N.D.	



Test Report

Report No.: 18360RC40003801

Page 34 of 135

Sample No.	Sample Description	Tested Items	XRF Screening Test Unit (mg/kg)	Chemical Test Unit (mg/kg)	Conclusion
94	Black inductor	Pb	BL	/	PASS
		Cd	BL	/	
		Hg	BL	/	
		Cr(Cr(VI))	X	N.D.	
		Br(PBBs&PBDEs)	BL	/	
		DBP	N.A.	N.D.	
		BBP	N.A.	N.D.	
		DEHP	N.A.	N.D.	
95	MOS tube	Pb	BL	/	PASS
		Cd	BL	/	
		Hg	BL	/	
		Cr(Cr(VI))	BL	/	
		Br(PBBs&PBDEs)	BL	/	
		DBP	N.A.	N.D.	
		BBP	N.A.	N.D.	
		DEHP	N.A.	N.D.	
96	Black inductor	Pb	BL	/	PASS
		Cd	BL	/	
		Hg	BL	/	
		Cr(Cr(VI))	BL	/	
		Br(PBBs&PBDEs)	BL	/	
		DBP	N.A.	N.D.	
		BBP	N.A.	N.D.	
		DEHP	N.A.	N.D.	
DIBP	N.A.	N.D.			



Test Report

Report No.: 18360RC40003801

Page 35 of 135

Sample No.	Sample Description	Tested Items	XRF Screening Test Unit (mg/kg)	Chemical Test Unit (mg/kg)	Conclusion
97	Green PCB board	Pb	BL	/	PASS
		Cd	BL	/	
		Hg	BL	/	
		Cr(Cr(VI))	BL	/	
		Br(PBBs&PBDEs)	X	N.D.	
		DBP	N.A.	N.D.	
		BBP	N.A.	N.D.	
		DEHP	N.A.	N.D.	
98	Silvery metal soldering tin	Pb	BL	/	PASS
		Cd	BL	/	
		Hg	BL	/	
		Cr(Cr(VI))	BL	/	
		Br(PBBs&PBDEs)	N.A.	/	
		DBP	N.A.	/	
		BBP	N.A.	/	
		DEHP	N.A.	/	
99	Chip resistor	Pb	BL	/	PASS
		Cd	BL	/	
		Hg	BL	/	
		Cr(Cr(VI))	BL	/	
		Br(PBBs&PBDEs)	BL	/	
		DBP	N.A.	N.D.	
		BBP	N.A.	N.D.	
		DEHP	N.A.	N.D.	
DIBP	N.A.	N.D.			



Test Report

Report No.: 18360RC40003801

Page 36 of 135

Sample No.	Sample Description	Tested Items	XRF Screening Test Unit (mg/kg)	Chemical Test Unit (mg/kg)	Conclusion
100	Silvery metal pin	Pb	BL	/	PASS
		Cd	BL	/	
		Hg	BL	/	
		Cr(Cr(VI))	BL	/	
		Br(PBBs&PBDEs)	N.A.	/	
		DBP	N.A.	/	
		BBP	N.A.	/	
		DEHP	N.A.	/	
101	Grey inductor	Pb	BL	/	PASS
		Cd	BL	/	
		Hg	BL	/	
		Cr(Cr(VI))	BL	/	
		Br(PBBs&PBDEs)	BL	/	
		DBP	N.A.	N.D.	
		BBP	N.A.	N.D.	
		DEHP	N.A.	N.D.	
102	IC	Pb	BL	/	PASS
		Cd	BL	/	
		Hg	BL	/	
		Cr(Cr(VI))	BL	/	
		Br(PBBs&PBDEs)	BL	/	
		DBP	N.A.	N.D.	
		BBP	N.A.	N.D.	
		DEHP	N.A.	N.D.	
DIBP	N.A.	N.D.			



Test Report

Report No.: 18360RC40003801

Page 37 of 135

Sample No.	Sample Description	Tested Items	XRF Screening Test Unit (mg/kg)	Chemical Test Unit (mg/kg)	Conclusion
103	Chip resistor	Pb	BL	/	PASS
		Cd	BL	/	
		Hg	BL	/	
		Cr(Cr(VI))	X	N.D.	
		Br(PBBs&PBDEs)	BL	/	
		DBP	N.A.	N.D.	
		BBP	N.A.	N.D.	
		DEHP	N.A.	N.D.	
104	Green PCB board	Pb	BL	/	PASS
		Cd	BL	/	
		Hg	BL	/	
		Cr(Cr(VI))	BL	/	
		Br(PBBs&PBDEs)	X	N.D.	
		DBP	N.A.	N.D.	
		BBP	N.A.	N.D.	
		DEHP	N.A.	N.D.	
105	White Chip capacitor	Pb	BL	/	PASS
		Cd	BL	/	
		Hg	BL	/	
		Cr(Cr(VI))	BL	/	
		Br(PBBs&PBDEs)	BL	/	
		DBP	N.A.	N.D.	
		BBP	N.A.	N.D.	
		DEHP	N.A.	N.D.	
DIBP	N.A.	N.D.			



Test Report

Report No.: 18360RC40003801

Page 38 of 135

Sample No.	Sample Description	Tested Items	XRF Screening Test Unit (mg/kg)	Chemical Test Unit (mg/kg)	Conclusion
106	Chip resistor	Pb	BL	/	PASS
		Cd	BL	/	
		Hg	BL	/	
		Cr(Cr(VI))	X	N.D.	
		Br(PBBs&PBDEs)	BL	/	
		DBP	N.A.	N.D.	
		BBP	N.A.	N.D.	
		DEHP	N.A.	N.D.	
107	Transparent plastic shell	Pb	BL	/	PASS
		Cd	BL	/	
		Hg	BL	/	
		Cr(Cr(VI))	BL	/	
		Br(PBBs&PBDEs)	BL	/	
		DBP	N.A.	N.D.	
		BBP	N.A.	N.D.	
		DEHP	N.A.	N.D.	
108	Translucent rubber ring	Pb	BL	/	PASS
		Cd	BL	/	
		Hg	BL	/	
		Cr(Cr(VI))	BL	/	
		Br(PBBs&PBDEs)	BL	/	
		DBP	N.A.	N.D.	
		BBP	N.A.	N.D.	
		DEHP	N.A.	N.D.	
DIBP	N.A.	N.D.			



Test Report

Report No.: 18360RC40003801

Page 39 of 135

Sample No.	Sample Description	Tested Items	XRF Screening Test Unit (mg/kg)	Chemical Test Unit (mg/kg)	Conclusion
109	Black plastic button	Pb	BL	/	PASS
		Cd	BL	/	
		Hg	BL	/	
		Cr(Cr(VI))	BL	/	
		Br(PBBs&PBDEs)	BL	/	
		DBP	N.A.	N.D.	
		BBP	N.A.	N.D.	
		DEHP	N.A.	N.D.	
110	White heat thermal shrinkable sleeve	Pb	BL	/	PASS
		Cd	BL	/	
		Hg	BL	/	
		Cr(Cr(VI))	BL	/	
		Br(PBBs&PBDEs)	BL	/	
		DBP	N.A.	N.D.	
		BBP	N.A.	N.D.	
		DEHP	N.A.	N.D.	
111	Black plastic jacket	Pb	BL	/	PASS
		Cd	BL	/	
		Hg	BL	/	
		Cr(Cr(VI))	BL	/	
		Br(PBBs&PBDEs)	BL	/	
		DBP	N.A.	N.D.	
		BBP	N.A.	N.D.	
		DEHP	N.A.	N.D.	
DIBP	N.A.	N.D.			



Test Report

Report No.: 18360RC40003801

Page 40 of 135

Sample No.	Sample Description	Tested Items	XRF Screening Test Unit (mg/kg)	Chemical Test Unit (mg/kg)	Conclusion
112	Purple plastic jacket	Pb	BL	/	PASS
		Cd	BL	/	
		Hg	BL	/	
		Cr(Cr(VI))	BL	/	
		Br(PBBs&PBDEs)	BL	/	
		DBP	N.A.	N.D.	
		BBP	N.A.	N.D.	
		DEHP	N.A.	N.D.	
113	White plastic jacket	Pb	BL	/	PASS
		Cd	BL	/	
		Hg	BL	/	
		Cr(Cr(VI))	BL	/	
		Br(PBBs&PBDEs)	BL	/	
		DBP	N.A.	N.D.	
		BBP	N.A.	N.D.	
		DEHP	N.A.	N.D.	
114	Grey plastic jacket	Pb	BL	/	PASS
		Cd	BL	/	
		Hg	BL	/	
		Cr(Cr(VI))	BL	/	
		Br(PBBs&PBDEs)	BL	/	
		DBP	N.A.	N.D.	
		BBP	N.A.	N.D.	
		DEHP	N.A.	N.D.	
DIBP	N.A.	N.D.			



Test Report

Report No.: 18360RC40003801

Page 41 of 135

Sample No.	Sample Description	Tested Items	XRF Screening Test Unit (mg/kg)	Chemical Test Unit (mg/kg)	Conclusion
115	Yellow plastic jacket	Pb	BL	/	PASS
		Cd	BL	/	
		Hg	BL	/	
		Cr(Cr(VI))	BL	/	
		Br(PBBs&PBDEs)	BL	/	
		DBP	N.A.	N.D.	
		BBP	N.A.	N.D.	
		DEHP	N.A.	N.D.	
116	Green plastic jacket	Pb	BL	/	PASS
		Cd	BL	/	
		Hg	BL	/	
		Cr(Cr(VI))	BL	/	
		Br(PBBs&PBDEs)	BL	/	
		DBP	N.A.	N.D.	
		BBP	N.A.	N.D.	
		DEHP	N.A.	N.D.	
117	Red plastic jacket	Pb	BL	/	PASS
		Cd	BL	/	
		Hg	BL	/	
		Cr(Cr(VI))	BL	/	
		Br(PBBs&PBDEs)	BL	/	
		DBP	N.A.	N.D.	
		BBP	N.A.	N.D.	
		DEHP	N.A.	N.D.	
DIBP	N.A.	N.D.			



Test Report

Report No.: 18360RC40003801

Page 42 of 135

Sample No.	Sample Description	Tested Items	XRF Screening Test Unit (mg/kg)	Chemical Test Unit (mg/kg)	Conclusion
118	Orange plastic jacket	Pb	BL	/	PASS
		Cd	BL	/	
		Hg	BL	/	
		Cr(Cr(VI))	BL	/	
		Br(PBBs&PBDEs)	BL	/	
		DBP	N.A.	N.D.	
		BBP	N.A.	N.D.	
		DEHP	N.A.	N.D.	
119	Black plastic jacket	Pb	BL	/	PASS
		Cd	BL	/	
		Hg	BL	/	
		Cr(Cr(VI))	BL	/	
		Br(PBBs&PBDEs)	BL	/	
		DBP	N.A.	N.D.	
		BBP	N.A.	N.D.	
		DEHP	N.A.	N.D.	
120	Blue plastic jacket	Pb	BL	/	PASS
		Cd	BL	/	
		Hg	BL	/	
		Cr(Cr(VI))	BL	/	
		Br(PBBs&PBDEs)	BL	/	
		DBP	N.A.	N.D.	
		BBP	N.A.	N.D.	
		DEHP	N.A.	N.D.	
DIBP	N.A.	N.D.			



Test Report

Report No.: 18360RC40003801

Page 43 of 135

Sample No.	Sample Description	Tested Items	XRF Screening Test Unit (mg/kg)	Chemical Test Unit (mg/kg)	Conclusion
121	White and green terminals	Pb	BL	/	PASS
		Cd	BL	/	
		Hg	BL	/	
		Cr(Cr(VI))	BL	/	
		Br(PBBs&PBDEs)	BL	/	
		DBP	N.A.	N.D.	
		BBP	N.A.	N.D.	
		DEHP	N.A.	N.D.	
122	Silvery metal pin	Pb	BL	/	PASS
		Cd	BL	/	
		Hg	BL	/	
		Cr(Cr(VI))	BL	/	
		Br(PBBs&PBDEs)	N.A.	/	
		DBP	N.A.	/	
		BBP	N.A.	/	
		DEHP	N.A.	/	
123	Chip bead	Pb	BL	/	PASS
		Cd	BL	/	
		Hg	BL	/	
		Cr(Cr(VI))	BL	/	
		Br(PBBs&PBDEs)	BL	/	
		DBP	N.A.	N.D.	
		BBP	N.A.	N.D.	
		DEHP	N.A.	N.D.	
DIBP	N.A.	N.D.			



Test Report

Report No.: 18360RC40003801

Page 44 of 135

Sample No.	Sample Description	Tested Items	XRF Screening Test Unit (mg/kg)	Chemical Test Unit (mg/kg)	Conclusion
124	Gray Chip capacitor	Pb	BL	/	PASS
		Cd	BL	/	
		Hg	BL	/	
		Cr(Cr(VI))	BL	/	
		Br(PBBs&PBDEs)	BL	/	
		DBP	N.A.	N.D.	
		BBP	N.A.	N.D.	
		DEHP	N.A.	N.D.	
125	LED	Pb	BL	/	PASS
		Cd	BL	/	
		Hg	BL	/	
		Cr(Cr(VI))	BL	/	
		Br(PBBs&PBDEs)	BL	/	
		DBP	N.A.	N.D.	
		BBP	N.A.	N.D.	
		DEHP	N.A.	N.D.	
126	LED	Pb	BL	/	PASS
		Cd	BL	/	
		Hg	BL	/	
		Cr(Cr(VI))	BL	/	
		Br(PBBs&PBDEs)	BL	/	
		DBP	N.A.	N.D.	
		BBP	N.A.	N.D.	
		DEHP	N.A.	N.D.	
DIBP	N.A.	N.D.			



Test Report

Report No.: 18360RC40003801

Page 45 of 135

Sample No.	Sample Description	Tested Items	XRF Screening Test Unit (mg/kg)	Chemical Test Unit (mg/kg)	Conclusion
127	Black plastic shell	Pb	BL	/	PASS
		Cd	BL	/	
		Hg	BL	/	
		Cr(Cr(VI))	BL	/	
		Br(PBBs&PBDEs)	BL	/	
		DBP	N.A.	N.D.	
		BBP	N.A.	N.D.	
		DEHP	N.A.	N.D.	
128	Copper-colored metal button	Pb	BL	/	PASS
		Cd	BL	/	
		Hg	BL	/	
		Cr(Cr(VI))	BL	/	
		Br(PBBs&PBDEs)	N.A.	/	
		DBP	N.A.	/	
		BBP	N.A.	/	
		DEHP	N.A.	/	
129	Yellow transparent adhesive tape	Pb	BL	/	PASS
		Cd	BL	/	
		Hg	BL	/	
		Cr(Cr(VI))	BL	/	
		Br(PBBs&PBDEs)	BL	/	
		DBP	N.A.	N.D.	
		BBP	N.A.	N.D.	
		DEHP	N.A.	N.D.	
DIBP	N.A.	N.D.			



Test Report

Report No.: 18360RC40003801

Page 46 of 135

Sample No.	Sample Description	Tested Items	XRF Screening Test Unit (mg/kg)	Chemical Test Unit (mg/kg)	Conclusion
130	Silvery metal shell	Pb	BL	/	PASS
		Cd	BL	/	
		Hg	BL	/	
		Cr(Cr(VI))	BL	/	
		Br(PBBs&PBDEs)	N.A.	/	
		DBP	N.A.	/	
		BBP	N.A.	/	
		DEHP	N.A.	/	
131	Silvery metal shrapnel	Pb	BL	/	PASS
		Cd	BL	/	
		Hg	BL	/	
		Cr(Cr(VI))	BL	/	
		Br(PBBs&PBDEs)	N.A.	/	
		DBP	N.A.	/	
		BBP	N.A.	/	
		DEHP	N.A.	/	
132	Grey inductor	Pb	BL	/	PASS
		Cd	BL	/	
		Hg	BL	/	
		Cr(Cr(VI))	X	N.D.	
		Br(PBBs&PBDEs)	BL	/	
		DBP	N.A.	N.D.	
		BBP	N.A.	N.D.	
		DEHP	N.A.	N.D.	
DIBP	N.A.	N.D.			



Test Report

Report No.: 18360RC40003801

Page 47 of 135

Sample No.	Sample Description	Tested Items	XRF Screening Test Unit (mg/kg)	Chemical Test Unit (mg/kg)	Conclusion
133	IC	Pb	BL	/	PASS
		Cd	BL	/	
		Hg	BL	/	
		Cr(Cr(VI))	BL	/	
		Br(PBBs&PBDEs)	BL	/	
		DBP	N.A.	N.D.	
		BBP	N.A.	N.D.	
		DEHP	N.A.	N.D.	
134	Chip capacitor	Pb	BL	/	PASS
		Cd	BL	/	
		Hg	BL	/	
		Cr(Cr(VI))	BL	/	
		Br(PBBs&PBDEs)	BL	/	
		DBP	N.A.	N.D.	
		BBP	N.A.	N.D.	
		DEHP	N.A.	N.D.	
135	Silvery metal sheet	Pb	BL	/	PASS
		Cd	BL	/	
		Hg	BL	/	
		Cr(Cr(VI))	BL	/	
		Br(PBBs&PBDEs)	N.A.	/	
		DBP	N.A.	/	
		BBP	N.A.	/	
		DEHP	N.A.	/	
		DIBP	N.A.	/	



Test Report

Report No.: 18360RC40003801

Page 48 of 135

Sample No.	Sample Description	Tested Items	XRF Screening Test Unit (mg/kg)	Chemical Test Unit (mg/kg)	Conclusion
136	IC	Pb	BL	/	PASS
		Cd	BL	/	
		Hg	BL	/	
		Cr(Cr(VI))	BL	/	
		Br(PBBs&PBDEs)	BL	/	
		DBP	N.A.	N.D.	
		BBP	N.A.	N.D.	
		DEHP	N.A.	N.D.	
137	IC	Pb	BL	/	PASS
		Cd	BL	/	
		Hg	BL	/	
		Cr(Cr(VI))	BL	/	
		Br(PBBs&PBDEs)	BL	/	
		DBP	N.A.	N.D.	
		BBP	N.A.	N.D.	
		DEHP	N.A.	N.D.	
138	Silvery metal pin	Pb	BL	/	PASS
		Cd	BL	/	
		Hg	BL	/	
		Cr(Cr(VI))	BL	/	
		Br(PBBs&PBDEs)	N.A.	/	
		DBP	N.A.	/	
		BBP	N.A.	/	
		DEHP	N.A.	/	
DIBP	N.A.	/			



Test Report

Report No.: 18360RC40003801

Page 49 of 135

Sample No.	Sample Description	Tested Items	XRF Screening Test Unit (mg/kg)	Chemical Test Unit (mg/kg)	Conclusion
139	Silvery metal shell	Pb	BL	/	PASS
		Cd	BL	/	
		Hg	BL	/	
		Cr(Cr(VI))	BL	/	
		Br(PBBs&PBDEs)	N.A.	/	
		DBP	N.A.	/	
		BBP	N.A.	/	
		DEHP	N.A.	/	
140	Black inductor	Pb	BL	/	PASS
		Cd	BL	/	
		Hg	BL	/	
		Cr(Cr(VI))	BL	/	
		Br(PBBs&PBDEs)	BL	/	
		DBP	N.A.	N.D.	
		BBP	N.A.	N.D.	
		DEHP	N.A.	N.D.	
141	Audion	Pb	BL	/	PASS
		Cd	BL	/	
		Hg	BL	/	
		Cr(Cr(VI))	BL	/	
		Br(PBBs&PBDEs)	BL	/	
		DBP	N.A.	N.D.	
		BBP	N.A.	N.D.	
		DEHP	N.A.	N.D.	
DIBP	N.A.	N.D.			



Test Report

Report No.: 18360RC40003801

Page 50 of 135

Sample No.	Sample Description	Tested Items	XRF Screening Test Unit (mg/kg)	Chemical Test Unit (mg/kg)	Conclusion
142	Chip diode	Pb	BL	/	PASS
		Cd	BL	/	
		Hg	BL	/	
		Cr(Cr(VI))	BL	/	
		Br(PBBs&PBDEs)	BL	/	
		DBP	N.A.	N.D.	
		BBP	N.A.	N.D.	
		DEHP	N.A.	N.D.	
143	Chip bead	Pb	BL	/	PASS
		Cd	BL	/	
		Hg	BL	/	
		Cr(Cr(VI))	BL	/	
		Br(PBBs&PBDEs)	BL	/	
		DBP	N.A.	N.D.	
		BBP	N.A.	N.D.	
		DEHP	N.A.	N.D.	
144	White glue	Pb	BL	/	PASS
		Cd	BL	/	
		Hg	BL	/	
		Cr(Cr(VI))	BL	/	
		Br(PBBs&PBDEs)	BL	/	
		DBP	N.A.	N.D.	
		BBP	N.A.	N.D.	
		DEHP	N.A.	N.D.	
DIBP	N.A.	N.D.			



Test Report

Report No.: 18360RC40003801

Page 51 of 135

Sample No.	Sample Description	Tested Items	XRF Screening Test Unit (mg/kg)	Chemical Test Unit (mg/kg)	Conclusion
145	IC	Pb	BL	/	PASS
		Cd	BL	/	
		Hg	BL	/	
		Cr(Cr(VI))	BL	/	
		Br(PBBs&PBDEs)	BL	/	
		DBP	N.A.	N.D.	
		BBP	N.A.	N.D.	
		DEHP	N.A.	N.D.	
146	Silvery metal pin	Pb	BL	/	PASS
		Cd	BL	/	
		Hg	BL	/	
		Cr(Cr(VI))	BL	/	
		Br(PBBs&PBDEs)	N.A.	/	
		DBP	N.A.	/	
		BBP	N.A.	/	
		DEHP	N.A.	/	
147	Silvery metal crystal oscillator	Pb	BL	/	PASS
		Cd	BL	/	
		Hg	BL	/	
		Cr(Cr(VI))	BL	/	
		Br(PBBs&PBDEs)	N.A.	/	
		DBP	N.A.	/	
		BBP	N.A.	/	
		DEHP	N.A.	/	
DIBP	N.A.	/			



Test Report

Report No.: 18360RC40003801

Page 52 of 135

Sample No.	Sample Description	Tested Items	XRF Screening Test Unit (mg/kg)	Chemical Test Unit (mg/kg)	Conclusion
148	White chip capacitor	Pb	BL	/	PASS
		Cd	BL	/	
		Hg	BL	/	
		Cr(Cr(VI))	BL	/	
		Br(PBBs&PBDEs)	BL	/	
		DBP	N.A.	N.D.	
		BBP	N.A.	N.D.	
		DEHP	N.A.	N.D.	
149	Silvery metal pin	Pb	BL	/	PASS
		Cd	BL	/	
		Hg	BL	/	
		Cr(Cr(VI))	BL	/	
		Br(PBBs&PBDEs)	N.A.	/	
		DBP	N.A.	/	
		BBP	N.A.	/	
		DEHP	N.A.	/	
150	Silvery metal pin	Pb	BL	/	PASS
		Cd	BL	/	
		Hg	BL	/	
		Cr(Cr(VI))	BL	/	
		Br(PBBs&PBDEs)	N.A.	/	
		DBP	N.A.	/	
		BBP	N.A.	/	
		DEHP	N.A.	/	
		DIBP	N.A.	/	



Test Report

Report No.: 18360RC40003801

Page 53 of 135

Sample No.	Sample Description	Tested Items	XRF Screening Test Unit (mg/kg)	Chemical Test Unit (mg/kg)	Conclusion
151	White plastic port	Pb	BL	/	PASS
		Cd	BL	/	
		Hg	BL	/	
		Cr(Cr(VI))	BL	/	
		Br(PBBs&PBDEs)	BL	/	
		DBP	N.A.	N.D.	
		BBP	N.A.	N.D.	
		DEHP	N.A.	N.D.	
		DIBP	N.A.	N.D.	
152	White plastic pedestal	Pb	BL	/	PASS
		Cd	BL	/	
		Hg	BL	/	
		Cr(Cr(VI))	BL	/	
		Br(PBBs&PBDEs)	BL	/	
		DBP	N.A.	N.D.	
		BBP	N.A.	N.D.	
		DEHP	N.A.	N.D.	
		DIBP	N.A.	N.D.	
153	Black PCB board	Pb	BL	/	PASS
		Cd	BL	/	
		Hg	BL	/	
		Cr(Cr(VI))	BL	/	
		Br(PBBs&PBDEs)	BL	/	
		DBP	N.A.	N.D.	
		BBP	N.A.	N.D.	
		DEHP	N.A.	N.D.	
		DIBP	N.A.	N.D.	



Test Report

Report No.: 18360RC40003801

Page 54 of 135

Sample No.	Sample Description	Tested Items	XRF Screening Test Unit (mg/kg)	Chemical Test Unit (mg/kg)	Conclusion
154	IC	Pb	BL	/	PASS
		Cd	BL	/	
		Hg	BL	/	
		Cr(Cr(VI))	BL	/	
		Br(PBBs&PBDEs)	BL	/	
		DBP	N.A.	N.D.	
		BBP	N.A.	N.D.	
		DEHP	N.A.	N.D.	
155	IC	Pb	BL	/	PASS
		Cd	BL	/	
		Hg	BL	/	
		Cr(Cr(VI))	BL	/	
		Br(PBBs&PBDEs)	BL	/	
		DBP	N.A.	N.D.	
		BBP	N.A.	N.D.	
		DEHP	N.A.	N.D.	
156	Chip resistor	Pb	BL	/	PASS
		Cd	BL	/	
		Hg	BL	/	
		Cr(Cr(VI))	X	N.D.	
		Br(PBBs&PBDEs)	BL	/	
		DBP	N.A.	N.D.	
		BBP	N.A.	N.D.	
		DEHP	N.A.	N.D.	
DIBP	N.A.	N.D.			



Test Report

Report No.: 18360RC40003801

Page 55 of 135

Sample No.	Sample Description	Tested Items	XRF Screening Test Unit (mg/kg)	Chemical Test Unit (mg/kg)	Conclusion
157	Chip diode	Pb	BL	/	PASS
		Cd	BL	/	
		Hg	BL	/	
		Cr(Cr(VI))	BL	/	
		Br(PBBs&PBDEs)	BL	/	
		DBP	N.A.	N.D.	
		BBP	N.A.	N.D.	
		DEHP	N.A.	N.D.	
158	IC	Pb	BL	/	PASS
		Cd	BL	/	
		Hg	BL	/	
		Cr(Cr(VI))	BL	/	
		Br(PBBs&PBDEs)	BL	/	
		DBP	N.A.	N.D.	
		BBP	N.A.	N.D.	
		DEHP	N.A.	N.D.	
159	Yellow transparent adhesive tape	Pb	BL	/	PASS
		Cd	BL	/	
		Hg	BL	/	
		Cr(Cr(VI))	BL	/	
		Br(PBBs&PBDEs)	BL	/	
		DBP	N.A.	N.D.	
		BBP	N.A.	N.D.	
		DEHP	N.A.	N.D.	
DIBP	N.A.	N.D.			



Test Report

Report No.: 18360RC40003801

Page 56 of 135

Sample No.	Sample Description	Tested Items	XRF Screening Test Unit (mg/kg)	Chemical Test Unit (mg/kg)	Conclusion
160	Green resistor	Pb	BL	/	PASS
		Cd	BL	/	
		Hg	BL	/	
		Cr(Cr(VI))	BL	/	
		Br(PBBs&PBDEs)	BL	/	
		DBP	N.A.	N.D.	
		BBP	N.A.	N.D.	
		DEHP	N.A.	N.D.	
161	White glue	Pb	BL	/	PASS
		Cd	BL	/	
		Hg	BL	/	
		Cr(Cr(VI))	BL	/	
		Br(PBBs&PBDEs)	BL	/	
		DBP	N.A.	N.D.	
		BBP	N.A.	N.D.	
		DEHP	N.A.	N.D.	
162	Silvery metal pin	Pb	BL	/	PASS
		Cd	BL	/	
		Hg	BL	/	
		Cr(Cr(VI))	BL	/	
		Br(PBBs&PBDEs)	N.A.	/	
		DBP	N.A.	/	
		BBP	N.A.	/	
		DEHP	N.A.	/	
DIBP	N.A.	/			



Test Report

Report No.: 18360RC40003801

Page 57 of 135

Sample No.	Sample Description	Tested Items	XRF Screening Test Unit (mg/kg)	Chemical Test Unit (mg/kg)	Conclusion
163	Chip capacitor	Pb	BL	/	PASS
		Cd	BL	/	
		Hg	BL	/	
		Cr(Cr(VI))	BL	/	
		Br(PBBs&PBDEs)	BL	/	
		DBP	N.A.	N.D.	
		BBP	N.A.	N.D.	
		DEHP	N.A.	N.D.	
164	Blue resistor	Pb	BL	/	PASS
		Cd	BL	/	
		Hg	BL	/	
		Cr(Cr(VI))	BL	/	
		Br(PBBs&PBDEs)	BL	/	
		DBP	N.A.	N.D.	
		BBP	N.A.	N.D.	
		DEHP	N.A.	N.D.	
165	Copper-colored metal shell	Pb	BL	/	PASS
		Cd	BL	/	
		Hg	BL	/	
		Cr(Cr(VI))	BL	/	
		Br(PBBs&PBDEs)	N.A.	/	
		DBP	N.A.	/	
		BBP	N.A.	/	
		DEHP	N.A.	/	
DIBP	N.A.	/			



Test Report

Report No.: 18360RC40003801

Page 58 of 135

Sample No.	Sample Description	Tested Items	XRF Screening Test Unit (mg/kg)	Chemical Test Unit (mg/kg)	Conclusion
166	Copper-colored metal contact pin	Pb	BL	/	PASS
		Cd	BL	/	
		Hg	BL	/	
		Cr(Cr(VI))	BL	/	
		Br(PBBs&PBDEs)	N.A.	/	
		DBP	N.A.	/	
		BBP	N.A.	/	
		DEHP	N.A.	/	
167	Chip fuse tube	Pb	BL	/	PASS
		Cd	BL	/	
		Hg	BL	/	
		Cr(Cr(VI))	BL	/	
		Br(PBBs&PBDEs)	BL	/	
		DBP	N.A.	N.D.	
		BBP	N.A.	N.D.	
		DEHP	N.A.	N.D.	
168	IC	Pb	BL	/	PASS
		Cd	BL	/	
		Hg	BL	/	
		Cr(Cr(VI))	BL	/	
		Br(PBBs&PBDEs)	BL	/	
		DBP	N.A.	N.D.	
		BBP	N.A.	N.D.	
		DEHP	N.A.	N.D.	
		DIBP	N.A.	N.D.	



Test Report

Report No.: 18360RC40003801

Page 59 of 135

Sample No.	Sample Description	Tested Items	XRF Screening Test Unit (mg/kg)	Chemical Test Unit (mg/kg)	Conclusion
169	Silvery metal pin	Pb	BL	/	PASS
		Cd	BL	/	
		Hg	BL	/	
		Cr(Cr(VI))	BL	/	
		Br(PBBs&PBDEs)	N.A.	/	
		DBP	N.A.	/	
		BBP	N.A.	/	
		DEHP	N.A.	/	
170	Silvery metal sheet	Pb	BL	/	PASS
		Cd	BL	/	
		Hg	BL	/	
		Cr(Cr(VI))	BL	/	
		Br(PBBs&PBDEs)	N.A.	/	
		DBP	N.A.	/	
		BBP	N.A.	/	
		DEHP	N.A.	/	
171	Green PCB board	Pb	BL	/	PASS
		Cd	BL	/	
		Hg	BL	/	
		Cr(Cr(VI))	BL	/	
		Br(PBBs&PBDEs)	X	N.D.	
		DBP	N.A.	N.D.	
		BBP	N.A.	N.D.	
		DEHP	N.A.	N.D.	
DIBP	N.A.	N.D.			



Test Report

Report No.: 18360RC40003801

Page 60 of 135

Sample No.	Sample Description	Tested Items	XRF Screening Test Unit (mg/kg)	Chemical Test Unit (mg/kg)	Conclusion
172	Silvery metal soldering tin	Pb	BL	/	PASS
		Cd	BL	/	
		Hg	BL	/	
		Cr(Cr(VI))	BL	/	
		Br(PBBs&PBDEs)	N.A.	/	
		DBP	N.A.	/	
		BBP	N.A.	/	
		DEHP	N.A.	/	
173	White plastic terminals	Pb	BL	/	PASS
		Cd	BL	/	
		Hg	BL	/	
		Cr(Cr(VI))	BL	/	
		Br(PBBs&PBDEs)	BL	/	
		DBP	N.A.	N.D.	
		BBP	N.A.	N.D.	
		DEHP	N.A.	N.D.	
174	Grey plastic jacket	Pb	BL	/	PASS
		Cd	BL	/	
		Hg	BL	/	
		Cr(Cr(VI))	BL	/	
		Br(PBBs&PBDEs)	BL	/	
		DBP	N.A.	N.D.	
		BBP	N.A.	N.D.	
		DEHP	N.A.	N.D.	
DIBP	N.A.	N.D.			



Test Report

Report No.: 18360RC40003801

Page 61 of 135

Sample No.	Sample Description	Tested Items	XRF Screening Test Unit (mg/kg)	Chemical Test Unit (mg/kg)	Conclusion
175	Brown plastic jacket	Pb	BL	/	PASS
		Cd	BL	/	
		Hg	BL	/	
		Cr(Cr(VI))	BL	/	
		Br(PBBs&PBDEs)	BL	/	
		DBP	N.A.	N.D.	
		BBP	N.A.	N.D.	
		DEHP	N.A.	N.D.	
		DIBP	N.A.	N.D.	
176	Red plastic jacket	Pb	BL	/	PASS
		Cd	BL	/	
		Hg	BL	/	
		Cr(Cr(VI))	BL	/	
		Br(PBBs&PBDEs)	BL	/	
		DBP	N.A.	N.D.	
		BBP	N.A.	N.D.	
		DEHP	N.A.	N.D.	
		DIBP	N.A.	N.D.	
177	White heat thermal shrinkable sleeve	Pb	BL	/	PASS
		Cd	BL	/	
		Hg	BL	/	
		Cr(Cr(VI))	BL	/	
		Br(PBBs&PBDEs)	BL	/	
		DBP	N.A.	N.D.	
		BBP	N.A.	N.D.	
		DEHP	N.A.	N.D.	
		DIBP	N.A.	N.D.	



Test Report

Report No.: 18360RC40003801

Page 62 of 135

Sample No.	Sample Description	Tested Items	XRF Screening Test Unit (mg/kg)	Chemical Test Unit (mg/kg)	Conclusion
178	Yellow plastic jacket	Pb	BL	/	PASS
		Cd	BL	/	
		Hg	BL	/	
		Cr(Cr(VI))	BL	/	
		Br(PBBs&PBDEs)	BL	/	
		DBP	N.A.	N.D.	
		BBP	N.A.	N.D.	
		DEHP	N.A.	N.D.	
179	Black plastic jacket	Pb	BL	/	PASS
		Cd	BL	/	
		Hg	BL	/	
		Cr(Cr(VI))	BL	/	
		Br(PBBs&PBDEs)	BL	/	
		DBP	N.A.	N.D.	
		BBP	N.A.	N.D.	
		DEHP	N.A.	N.D.	
180	Blue plastic jacket	Pb	BL	/	PASS
		Cd	BL	/	
		Hg	BL	/	
		Cr(Cr(VI))	BL	/	
		Br(PBBs&PBDEs)	BL	/	
		DBP	N.A.	N.D.	
		BBP	N.A.	N.D.	
		DEHP	N.A.	N.D.	
DIBP	N.A.	N.D.			



Test Report

Report No.: 18360RC40003801

Page 63 of 135

Sample No.	Sample Description	Tested Items	XRF Screening Test Unit (mg/kg)	Chemical Test Unit (mg/kg)	Conclusion
181	Brown plastic jacket	Pb	BL	/	PASS
		Cd	BL	/	
		Hg	BL	/	
		Cr(Cr(VI))	BL	/	
		Br(PBBs&PBDEs)	BL	/	
		DBP	N.A.	N.D.	
		BBP	N.A.	N.D.	
		DEHP	N.A.	N.D.	
182	Purple plastic jacket	Pb	BL	/	PASS
		Cd	BL	/	
		Hg	BL	/	
		Cr(Cr(VI))	BL	/	
		Br(PBBs&PBDEs)	BL	/	
		DBP	N.A.	N.D.	
		BBP	N.A.	N.D.	
		DEHP	N.A.	N.D.	
183	Green plastic jacket	Pb	BL	/	PASS
		Cd	BL	/	
		Hg	BL	/	
		Cr(Cr(VI))	BL	/	
		Br(PBBs&PBDEs)	BL	/	
		DBP	N.A.	N.D.	
		BBP	N.A.	N.D.	
		DEHP	N.A.	N.D.	
DIBP	N.A.	N.D.			



Test Report

Report No.: 18360RC40003801

Page 64 of 135

Sample No.	Sample Description	Tested Items	XRF Screening Test Unit (mg/kg)	Chemical Test Unit (mg/kg)	Conclusion
184	Black plastic port	Pb	BL	/	PASS
		Cd	BL	/	
		Hg	BL	/	
		Cr(Cr(VI))	BL	/	
		Br(PBBs&PBDEs)	X	N.D.	
		DBP	N.A.	N.D.	
		BBP	N.A.	N.D.	
		DEHP	N.A.	N.D.	
185	Silvery metal pin	Pb	BL	/	PASS
		Cd	BL	/	
		Hg	BL	/	
		Cr(Cr(VI))	BL	/	
		Br(PBBs&PBDEs)	N.A.	/	
		DBP	N.A.	/	
		BBP	N.A.	/	
		DEHP	N.A.	/	
186	Silvery metal shell	Pb	BL	/	PASS
		Cd	BL	/	
		Hg	BL	/	
		Cr(Cr(VI))	BL	/	
		Br(PBBs&PBDEs)	N.A.	/	
		DBP	N.A.	/	
		BBP	N.A.	/	
		DEHP	N.A.	/	
DIBP	N.A.	/			



Test Report

Report No.: 18360RC40003801

Page 65 of 135

Sample No.	Sample Description	Tested Items	XRF Screening Test Unit (mg/kg)	Chemical Test Unit (mg/kg)	Conclusion
187	Black plastic pedestal	Pb	BL	/	PASS
		Cd	BL	/	
		Hg	BL	/	
		Cr(Cr(VI))	BL	/	
		Br(PBBs&PBDEs)	BL	/	
		DBP	N.A.	N.D.	
		BBP	N.A.	N.D.	
		DEHP	N.A.	N.D.	
188	Silvery metal shell	Pb	BL	/	PASS
		Cd	BL	/	
		Hg	BL	/	
		Cr(Cr(VI))	BL	/	
		Br(PBBs&PBDEs)	N.A.	/	
		DBP	N.A.	/	
		BBP	N.A.	/	
		DEHP	N.A.	/	
189	Green PCB board	Pb	BL	/	PASS
		Cd	BL	/	
		Hg	BL	/	
		Cr(Cr(VI))	BL	/	
		Br(PBBs&PBDEs)	X	N.D.	
		DBP	N.A.	N.D.	
		BBP	N.A.	N.D.	
		DEHP	N.A.	N.D.	
DIBP	N.A.	N.D.			



Test Report

Report No.: 18360RC40003801

Page 66 of 135

Sample No.	Sample Description	Tested Items	XRF Screening Test Unit (mg/kg)	Chemical Test Unit (mg/kg)	Conclusion
190	Copper-colored metal shell	Pb	OL	22778*	PASS
		Cd	BL	/	
		Hg	BL	/	
		Cr(Cr(VI))	BL	/	
		Br(PBBs&PBDEs)	N.A.	/	
		DBP	N.A.	/	
		BBP	N.A.	/	
		DEHP	N.A.	/	
191	Silvery metal soldering tin	Pb	BL	/	PASS
		Cd	BL	/	
		Hg	BL	/	
		Cr(Cr(VI))	BL	/	
		Br(PBBs&PBDEs)	N.A.	/	
		DBP	N.A.	/	
		BBP	N.A.	/	
		DEHP	N.A.	/	
192	LED	Pb	BL	/	PASS
		Cd	BL	/	
		Hg	BL	/	
		Cr(Cr(VI))	BL	/	
		Br(PBBs&PBDEs)	BL	/	
		DBP	N.A.	N.D.	
		BBP	N.A.	N.D.	
		DEHP	N.A.	N.D.	
DIBP	N.A.	N.D.			



Test Report

Report No.: 18360RC40003801

Page 67 of 135

Sample No.	Sample Description	Tested Items	XRF Screening Test Unit (mg/kg)	Chemical Test Unit (mg/kg)	Conclusion
193	Black inductor	Pb	BL	/	PASS
		Cd	BL	/	
		Hg	BL	/	
		Cr(Cr(VI))	X	N.D.	
		Br(PBBs&PBDEs)	BL	/	
		DBP	N.A.	N.D.	
		BBP	N.A.	N.D.	
		DEHP	N.A.	N.D.	
194	IC	Pb	BL	/	PASS
		Cd	BL	/	
		Hg	BL	/	
		Cr(Cr(VI))	BL	/	
		Br(PBBs&PBDEs)	BL	/	
		DBP	N.A.	N.D.	
		BBP	N.A.	N.D.	
		DEHP	N.A.	N.D.	
195	Copper-colored metal socket	Pb	BL	/	PASS
		Cd	BL	/	
		Hg	BL	/	
		Cr(Cr(VI))	BL	/	
		Br(PBBs&PBDEs)	N.A.	/	
		DBP	N.A.	/	
		BBP	N.A.	/	
		DEHP	N.A.	/	
DIBP	N.A.	/			



Test Report

Report No.: 18360RC40003801

Page 68 of 135

Sample No.	Sample Description	Tested Items	XRF Screening Test Unit (mg/kg)	Chemical Test Unit (mg/kg)	Conclusion
196	White inner plastic	Pb	BL	/	PASS
		Cd	BL	/	
		Hg	BL	/	
		Cr(Cr(VI))	BL	/	
		Br(PBBs&PBDEs)	BL	/	
		DBP	N.A.	N.D.	
		BBP	N.A.	N.D.	
		DEHP	N.A.	N.D.	
197	IC	Pb	BL	/	PASS
		Cd	BL	/	
		Hg	BL	/	
		Cr(Cr(VI))	BL	/	
		Br(PBBs&PBDEs)	BL	/	
		DBP	N.A.	N.D.	
		BBP	N.A.	N.D.	
		DEHP	N.A.	N.D.	
198	Chip resistor	Pb	BL	/	PASS
		Cd	BL	/	
		Hg	BL	/	
		Cr(Cr(VI))	BL	/	
		Br(PBBs&PBDEs)	BL	/	
		DBP	N.A.	N.D.	
		BBP	N.A.	N.D.	
		DEHP	N.A.	N.D.	
DIBP	N.A.	N.D.			



Test Report

Report No.: 18360RC40003801

Page 69 of 135

Sample No.	Sample Description	Tested Items	XRF Screening Test Unit (mg/kg)	Chemical Test Unit (mg/kg)	Conclusion
199	Silvery metal crystal oscillator	Pb	BL	/	PASS
		Cd	BL	/	
		Hg	BL	/	
		Cr(Cr(VI))	BL	/	
		Br(PBBs&PBDEs)	N.A.	/	
		DBP	N.A.	/	
		BBP	N.A.	/	
		DEHP	N.A.	/	
200	Green PCB board	Pb	BL	/	PASS
		Cd	BL	/	
		Hg	BL	/	
		Cr(Cr(VI))	BL	/	
		Br(PBBs&PBDEs)	X	N.D.	
		DBP	N.A.	N.D.	
		BBP	N.A.	N.D.	
		DEHP	N.A.	N.D.	
201	Black rubber block	Pb	BL	/	PASS
		Cd	BL	/	
		Hg	BL	/	
		Cr(Cr(VI))	BL	/	
		Br(PBBs&PBDEs)	BL	/	
		DBP	N.A.	N.D.	
		BBP	N.A.	N.D.	
		DEHP	N.A.	N.D.	
DIBP	N.A.	N.D.			



Test Report

Report No.: 18360RC40003801

Page 70 of 135

Sample No.	Sample Description	Tested Items	XRF Screening Test Unit (mg/kg)	Chemical Test Unit (mg/kg)	Conclusion
202	Black plastic jacket	Pb	BL	/	PASS
		Cd	BL	/	
		Hg	BL	/	
		Cr(Cr(VI))	BL	/	
		Br(PBBs&PBDEs)	BL	/	
		DBP	N.A.	N.D.	
		BBP	N.A.	N.D.	
		DEHP	N.A.	N.D.	
203	Silvery metal sheet	Pb	BL	/	PASS
		Cd	BL	/	
		Hg	BL	/	
		Cr(Cr(VI))	BL	/	
		Br(PBBs&PBDEs)	N.A.	/	
		DBP	N.A.	/	
		BBP	N.A.	/	
		DEHP	N.A.	/	
204	Silvery metal antenna	Pb	BL	/	PASS
		Cd	BL	/	
		Hg	BL	/	
		Cr(Cr(VI))	BL	/	
		Br(PBBs&PBDEs)	N.A.	/	
		DBP	N.A.	/	
		BBP	N.A.	/	
		DEHP	N.A.	/	
DIBP	N.A.	/			



Test Report

Report No.: 18360RC40003801

Page 71 of 135

Sample No.	Sample Description	Tested Items	XRF Screening Test Unit (mg/kg)	Chemical Test Unit (mg/kg)	Conclusion
205	Black inner plastic	Pb	BL	/	PASS
		Cd	BL	/	
		Hg	BL	/	
		Cr(Cr(VI))	BL	/	
		Br(PBBs&PBDEs)	BL	/	
		DBP	N.A.	N.D.	
		BBP	N.A.	N.D.	
		DEHP	N.A.	N.D.	
206	White glue	Pb	BL	/	PASS
		Cd	BL	/	
		Hg	BL	/	
		Cr(Cr(VI))	BL	/	
		Br(PBBs&PBDEs)	BL	/	
		DBP	N.A.	N.D.	
		BBP	N.A.	N.D.	
		DEHP	N.A.	N.D.	
207	Silvery metal sheet	Pb	BL	/	PASS
		Cd	BL	/	
		Hg	BL	/	
		Cr(Cr(VI))	BL	/	
		Br(PBBs&PBDEs)	N.A.	/	
		DBP	N.A.	/	
		BBP	N.A.	/	
		DEHP	N.A.	/	
		DIBP	N.A.	/	



Test Report

Report No.: 18360RC40003801

Page 72 of 135

Sample No.	Sample Description	Tested Items	XRF Screening Test Unit (mg/kg)	Chemical Test Unit (mg/kg)	Conclusion
208	Copper-colored metal patch resistor	Pb	BL	/	PASS
		Cd	BL	/	
		Hg	BL	/	
		Cr(Cr(VI))	BL	/	
		Br(PBBs&PBDEs)	N.A.	/	
		DBP	N.A.	/	
		BBP	N.A.	/	
		DEHP	N.A.	/	
209	Black plastic jacket	Pb	BL	/	PASS
		Cd	BL	/	
		Hg	BL	/	
		Cr(Cr(VI))	BL	/	
		Br(PBBs&PBDEs)	BL	/	
		DBP	N.A.	N.D.	
		BBP	N.A.	N.D.	
		DEHP	N.A.	N.D.	
210	Blue magnet frame	Pb	BL	/	PASS
		Cd	BL	/	
		Hg	BL	/	
		Cr(Cr(VI))	BL	/	
		Br(PBBs&PBDEs)	BL	/	
		DBP	N.A.	N.D.	
		BBP	N.A.	N.D.	
		DEHP	N.A.	N.D.	
DIBP	N.A.	N.D.			



Test Report

Report No.: 18360RC40003801

Page 73 of 135

Sample No.	Sample Description	Tested Items	XRF Screening Test Unit (mg/kg)	Chemical Test Unit (mg/kg)	Conclusion
211	Gray Chip capacitor	Pb	BL	/	PASS
		Cd	BL	/	
		Hg	BL	/	
		Cr(Cr(VI))	BL	/	
		Br(PBBs&PBDEs)	BL	/	
		DBP	N.A.	N.D.	
		BBP	N.A.	N.D.	
		DEHP	N.A.	N.D.	
212	Black inductor	Pb	BL	/	PASS
		Cd	BL	/	
		Hg	BL	/	
		Cr(Cr(VI))	BL	/	
		Br(PBBs&PBDEs)	BL	/	
		DBP	N.A.	N.D.	
		BBP	N.A.	N.D.	
		DEHP	N.A.	N.D.	
213	Yellow transparent adhesive tape	Pb	BL	/	PASS
		Cd	BL	/	
		Hg	BL	/	
		Cr(Cr(VI))	BL	/	
		Br(PBBs&PBDEs)	BL	/	
		DBP	N.A.	N.D.	
		BBP	N.A.	N.D.	
		DEHP	N.A.	N.D.	
DIBP	N.A.	N.D.			



Test Report

Report No.: 18360RC40003801

Page 74 of 135

Sample No.	Sample Description	Tested Items	XRF Screening Test Unit (mg/kg)	Chemical Test Unit (mg/kg)	Conclusion
214	Copper-colored metal coil	Pb	BL	/	PASS
		Cd	BL	/	
		Hg	BL	/	
		Cr(Cr(VI))	BL	/	
		Br(PBBs&PBDEs)	N.A.	/	
		DBP	N.A.	/	
		BBP	N.A.	/	
		DEHP	N.A.	/	
215	Gray capacitor	Pb	BL	/	PASS
		Cd	BL	/	
		Hg	BL	/	
		Cr(Cr(VI))	BL	/	
		Br(PBBs&PBDEs)	X	N.D.	
		DBP	N.A.	N.D.	
		BBP	N.A.	N.D.	
		DEHP	N.A.	N.D.	
216	Silvery metal contact pin	Pb	BL	/	PASS
		Cd	BL	/	
		Hg	BL	/	
		Cr(Cr(VI))	BL	/	
		Br(PBBs&PBDEs)	N.A.	/	
		DBP	N.A.	/	
		BBP	N.A.	/	
		DEHP	N.A.	/	
		DIBP	N.A.	/	



Test Report

Report No.: 18360RC40003801

Page 75 of 135

Sample No.	Sample Description	Tested Items	XRF Screening Test Unit (mg/kg)	Chemical Test Unit (mg/kg)	Conclusion
217	Black plastic block	Pb	BL	/	PASS
		Cd	BL	/	
		Hg	BL	/	
		Cr(Cr(VI))	BL	/	
		Br(PBBs&PBDEs)	BL	/	
		DBP	N.A.	N.D.	
		BBP	N.A.	N.D.	
		DEHP	N.A.	N.D.	
218	Copper-colored metal pin	Pb	BL	/	PASS
		Cd	BL	/	
		Hg	BL	/	
		Cr(Cr(VI))	BL	/	
		Br(PBBs&PBDEs)	N.A.	/	
		DBP	N.A.	/	
		BBP	N.A.	/	
		DEHP	N.A.	/	
219	Silvery metal soldering tin	Pb	BL	/	PASS
		Cd	BL	/	
		Hg	BL	/	
		Cr(Cr(VI))	BL	/	
		Br(PBBs&PBDEs)	N.A.	/	
		DBP	N.A.	/	
		BBP	N.A.	/	
		DEHP	N.A.	/	
		DIBP	N.A.	/	



Test Report

Report No.: 18360RC40003801

Page 76 of 135

Sample No.	Sample Description	Tested Items	XRF Screening Test Unit (mg/kg)	Chemical Test Unit (mg/kg)	Conclusion
220	Blue electrolytic capacitor scarfskin	Pb	BL	/	PASS
		Cd	BL	/	
		Hg	BL	/	
		Cr(Cr(VI))	BL	/	
		Br(PBBs&PBDEs)	BL	/	
		DBP	N.A.	N.D.	
		BBP	N.A.	N.D.	
		DEHP	N.A.	N.D.	
221	Silvery metal sheet	Pb	BL	/	PASS
		Cd	BL	/	
		Hg	BL	/	
		Cr(Cr(VI))	BL	/	
		Br(PBBs&PBDEs)	N.A.	/	
		DBP	N.A.	/	
		BBP	N.A.	/	
		DEHP	N.A.	/	
222	Grey plastic sheet	Pb	BL	/	PASS
		Cd	BL	/	
		Hg	BL	/	
		Cr(Cr(VI))	BL	/	
		Br(PBBs&PBDEs)	BL	/	
		DBP	N.A.	N.D.	
		BBP	N.A.	N.D.	
		DEHP	N.A.	N.D.	
DIBP	N.A.	N.D.			



Test Report

Report No.: 18360RC40003801

Page 77 of 135

Sample No.	Sample Description	Tested Items	XRF Screening Test Unit (mg/kg)	Chemical Test Unit (mg/kg)	Conclusion
223	Green capacitor	Pb	BL	/	PASS
		Cd	BL	/	
		Hg	BL	/	
		Cr(Cr(VI))	BL	/	
		Br(PBBs&PBDEs)	BL	/	
		DBP	N.A.	N.D.	
		BBP	N.A.	N.D.	
		DEHP	N.A.	N.D.	
224	Black inductor	Pb	BL	/	PASS
		Cd	BL	/	
		Hg	BL	/	
		Cr(Cr(VI))	BL	/	
		Br(PBBs&PBDEs)	BL	/	
		DBP	N.A.	N.D.	
		BBP	N.A.	N.D.	
		DEHP	N.A.	N.D.	
225	Copper-colored metal coil	Pb	BL	/	PASS
		Cd	BL	/	
		Hg	BL	/	
		Cr(Cr(VI))	BL	/	
		Br(PBBs&PBDEs)	N.A.	/	
		DBP	N.A.	/	
		BBP	N.A.	/	
		DEHP	N.A.	/	
		DIBP	N.A.	/	



Test Report

Report No.: 18360RC40003801

Page 78 of 135

Sample No.	Sample Description	Tested Items	XRF Screening Test Unit (mg/kg)	Chemical Test Unit (mg/kg)	Conclusion
226	Copper-colored metal coil	Pb	BL	/	PASS
		Cd	BL	/	
		Hg	BL	/	
		Cr(Cr(VI))	BL	/	
		Br(PBBs&PBDEs)	N.A.	/	
		DBP	N.A.	/	
		BBP	N.A.	/	
		DEHP	N.A.	/	
227	Black relay	Pb	BL	/	PASS
		Cd	BL	/	
		Hg	BL	/	
		Cr(Cr(VI))	BL	/	
		Br(PBBs&PBDEs)	X	N.D.	
		DBP	N.A.	N.D.	
		BBP	N.A.	N.D.	
		DEHP	N.A.	N.D.	
228	Translucent plastic jacket	Pb	BL	/	PASS
		Cd	BL	/	
		Hg	BL	/	
		Cr(Cr(VI))	BL	/	
		Br(PBBs&PBDEs)	BL	/	
		DBP	N.A.	N.D.	
		BBP	N.A.	N.D.	
		DEHP	N.A.	N.D.	
DIBP	N.A.	N.D.			



Test Report

Report No.: 18360RC40003801

Page 79 of 135

Sample No.	Sample Description	Tested Items	XRF Screening Test Unit (mg/kg)	Chemical Test Unit (mg/kg)	Conclusion
229	Gray capacitor	Pb	BL	/	PASS
		Cd	BL	/	
		Hg	BL	/	
		Cr(Cr(VI))	BL	/	
		Br(PBBs&PBDEs)	X	N.D.	
		DBP	N.A.	N.D.	
		BBP	N.A.	N.D.	
		DEHP	N.A.	N.D.	
230	Black heat thermal shrinkable sleeve	Pb	BL	/	PASS
		Cd	BL	/	
		Hg	BL	/	
		Cr(Cr(VI))	BL	/	
		Br(PBBs&PBDEs)	BL	/	
		DBP	N.A.	N.D.	
		BBP	N.A.	N.D.	
		DEHP	N.A.	N.D.	
231	Black plastic frame	Pb	BL	/	PASS
		Cd	BL	/	
		Hg	BL	/	
		Cr(Cr(VI))	BL	/	
		Br(PBBs&PBDEs)	BL	/	
		DBP	N.A.	N.D.	
		BBP	N.A.	N.D.	
		DEHP	N.A.	N.D.	
DIBP	N.A.	N.D.			



Test Report

Report No.: 18360RC40003801

Page 80 of 135

Sample No.	Sample Description	Tested Items	XRF Screening Test Unit (mg/kg)	Chemical Test Unit (mg/kg)	Conclusion
232	Copper-colored metal coil	Pb	BL	/	PASS
		Cd	BL	/	
		Hg	BL	/	
		Cr(Cr(VI))	BL	/	
		Br(PBBs&PBDEs)	N.A.	/	
		DBP	N.A.	/	
		BBP	N.A.	/	
		DEHP	N.A.	/	
233	Black magnet frame	Pb	BL	/	PASS
		Cd	BL	/	
		Hg	BL	/	
		Cr(Cr(VI))	BL	/	
		Br(PBBs&PBDEs)	BL	/	
		DBP	N.A.	N.D.	
		BBP	N.A.	N.D.	
		DEHP	N.A.	N.D.	
234	Silvery metal pin	Pb	BL	/	PASS
		Cd	BL	/	
		Hg	BL	/	
		Cr(Cr(VI))	BL	/	
		Br(PBBs&PBDEs)	N.A.	/	
		DBP	N.A.	/	
		BBP	N.A.	/	
		DEHP	N.A.	/	
		DIBP	N.A.	/	



Test Report

Report No.: 18360RC40003801

Page 81 of 135

Sample No.	Sample Description	Tested Items	XRF Screening Test Unit (mg/kg)	Chemical Test Unit (mg/kg)	Conclusion
235	Fuse	Pb	BL	/	PASS
		Cd	BL	/	
		Hg	BL	/	
		Cr(Cr(VI))	BL	/	
		Br(PBBs&PBDEs)	BL	/	
		DBP	N.A.	N.D.	
		BBP	N.A.	N.D.	
		DEHP	N.A.	N.D.	
236	Black heat thermal shrinkable sleeve	Pb	BL	/	PASS
		Cd	BL	/	
		Hg	BL	/	
		Cr(Cr(VI))	BL	/	
		Br(PBBs&PBDEs)	BL	/	
		DBP	N.A.	N.D.	
		BBP	N.A.	N.D.	
		DEHP	N.A.	N.D.	
237	Silvery metal sheet	Pb	BL	/	PASS
		Cd	BL	/	
		Hg	BL	/	
		Cr(Cr(VI))	BL	/	
		Br(PBBs&PBDEs)	N.A.	/	
		DBP	N.A.	/	
		BBP	N.A.	/	
		DEHP	N.A.	/	
		DIBP	N.A.	/	



Test Report

Report No.: 18360RC40003801

Page 82 of 135

Sample No.	Sample Description	Tested Items	XRF Screening Test Unit (mg/kg)	Chemical Test Unit (mg/kg)	Conclusion
238	Chip resistor	Pb	BL	/	PASS
		Cd	BL	/	
		Hg	BL	/	
		Cr(Cr(VI))	X	N.D.	
		Br(PBBs&PBDEs)	BL	/	
		DBP	N.A.	N.D.	
		BBP	N.A.	N.D.	
		DEHP	N.A.	N.D.	
239	Silvery metal sheet	Pb	BL	/	PASS
		Cd	BL	/	
		Hg	BL	/	
		Cr(Cr(VI))	BL	/	
		Br(PBBs&PBDEs)	N.A.	/	
		DBP	N.A.	/	
		BBP	N.A.	/	
		DEHP	N.A.	/	
240	Gas discharge tube	Pb	BL	/	PASS
		Cd	BL	/	
		Hg	BL	/	
		Cr(Cr(VI))	BL	/	
		Br(PBBs&PBDEs)	BL	/	
		DBP	N.A.	N.D.	
		BBP	N.A.	N.D.	
		DEHP	N.A.	N.D.	
		DIBP	N.A.	N.D.	



Test Report

Report No.: 18360RC40003801

Page 83 of 135

Sample No.	Sample Description	Tested Items	XRF Screening Test Unit (mg/kg)	Chemical Test Unit (mg/kg)	Conclusion
241	Transparent adhesive	Pb	BL	/	PASS
		Cd	BL	/	
		Hg	BL	/	
		Cr(Cr(VI))	BL	/	
		Br(PBBs&PBDEs)	BL	/	
		DBP	N.A.	N.D.	
		BBP	N.A.	N.D.	
		DEHP	N.A.	N.D.	
242	IC	Pb	BL	/	PASS
		Cd	BL	/	
		Hg	BL	/	
		Cr(Cr(VI))	BL	/	
		Br(PBBs&PBDEs)	BL	/	
		DBP	N.A.	N.D.	
		BBP	N.A.	N.D.	
		DEHP	N.A.	N.D.	
243	Grey inductor	Pb	BL	/	PASS
		Cd	BL	/	
		Hg	BL	/	
		Cr(Cr(VI))	X	N.D.	
		Br(PBBs&PBDEs)	BL	/	
		DBP	N.A.	N.D.	
		BBP	N.A.	N.D.	
		DEHP	N.A.	N.D.	
DIBP	N.A.	N.D.			



Test Report

Report No.: 18360RC40003801

Page 84 of 135

Sample No.	Sample Description	Tested Items	XRF Screening Test Unit (mg/kg)	Chemical Test Unit (mg/kg)	Conclusion
244	Silvery metal soldering tin	Pb	BL	/	PASS
		Cd	BL	/	
		Hg	BL	/	
		Cr(Cr(VI))	BL	/	
		Br(PBBs&PBDEs)	N.A.	/	
		DBP	N.A.	/	
		BBP	N.A.	/	
		DEHP	N.A.	/	
245	IC	Pb	BL	/	PASS
		Cd	BL	/	
		Hg	BL	/	
		Cr(Cr(VI))	BL	/	
		Br(PBBs&PBDEs)	BL	/	
		DBP	N.A.	N.D.	
		BBP	N.A.	N.D.	
		DEHP	N.A.	N.D.	
246	Green PCB board	Pb	BL	/	PASS
		Cd	BL	/	
		Hg	BL	/	
		Cr(Cr(VI))	BL	/	
		Br(PBBs&PBDEs)	X	N.D.	
		DBP	N.A.	N.D.	
		BBP	N.A.	N.D.	
		DEHP	N.A.	N.D.	
DIBP	N.A.	N.D.			



Test Report

Report No.: 18360RC40003801

Page 85 of 135

Sample No.	Sample Description	Tested Items	XRF Screening Test Unit (mg/kg)	Chemical Test Unit (mg/kg)	Conclusion
247	Silvery metal shell	Pb	BL	/	PASS
		Cd	BL	/	
		Hg	BL	/	
		Cr(Cr(VI))	BL	/	
		Br(PBBs&PBDEs)	N.A.	/	
		DBP	N.A.	/	
		BBP	N.A.	/	
		DEHP	N.A.	/	
248	Black electrolytic capacitor scarfskin	Pb	BL	/	PASS
		Cd	BL	/	
		Hg	BL	/	
		Cr(Cr(VI))	BL	/	
		Br(PBBs&PBDEs)	BL	/	
		DBP	N.A.	N.D.	
		BBP	N.A.	N.D.	
		DEHP	N.A.	N.D.	
249	Black rubber stopper	Pb	BL	/	PASS
		Cd	BL	/	
		Hg	BL	/	
		Cr(Cr(VI))	BL	/	
		Br(PBBs&PBDEs)	BL	/	
		DBP	N.A.	N.D.	
		BBP	N.A.	N.D.	
		DEHP	N.A.	N.D.	
DIBP	N.A.	N.D.			



Test Report

Report No.: 18360RC40003801

Page 86 of 135

Sample No.	Sample Description	Tested Items	XRF Screening Test Unit (mg/kg)	Chemical Test Unit (mg/kg)	Conclusion
250	Gray metal foil sheet	Pb	BL	/	PASS
		Cd	BL	/	
		Hg	BL	/	
		Cr(Cr(VI))	BL	/	
		Br(PBBs&PBDEs)	N.A.	/	
		DBP	N.A.	/	
		BBP	N.A.	/	
		DEHP	N.A.	/	
251	Silvery metal foil sheet	Pb	BL	/	PASS
		Cd	BL	/	
		Hg	BL	/	
		Cr(Cr(VI))	BL	/	
		Br(PBBs&PBDEs)	N.A.	/	
		DBP	N.A.	/	
		BBP	N.A.	/	
		DEHP	N.A.	/	
252	Brown paper	Pb	BL	/	PASS
		Cd	BL	/	
		Hg	BL	/	
		Cr(Cr(VI))	BL	/	
		Br(PBBs&PBDEs)	BL	/	
		DBP	N.A.	N.D.	
		BBP	N.A.	N.D.	
		DEHP	N.A.	N.D.	
DIBP	N.A.	N.D.			



Test Report

Report No.: 18360RC40003801

Page 87 of 135

Sample No.	Sample Description	Tested Items	XRF Screening Test Unit (mg/kg)	Chemical Test Unit (mg/kg)	Conclusion
253	Transparent adhesive tape	Pb	BL	/	PASS
		Cd	BL	/	
		Hg	BL	/	
		Cr(Cr(VI))	BL	/	
		Br(PBBs&PBDEs)	BL	/	
		DBP	N.A.	N.D.	
		BBP	N.A.	N.D.	
		DEHP	N.A.	N.D.	
254	Black plastic jacket	Pb	BL	/	PASS
		Cd	BL	/	
		Hg	BL	/	
		Cr(Cr(VI))	BL	/	
		Br(PBBs&PBDEs)	BL	/	
		DBP	N.A.	N.D.	
		BBP	N.A.	N.D.	
		DEHP	N.A.	N.D.	
255	Red plastic jacket	Pb	BL	/	PASS
		Cd	BL	/	
		Hg	BL	/	
		Cr(Cr(VI))	BL	/	
		Br(PBBs&PBDEs)	BL	/	
		DBP	N.A.	N.D.	
		BBP	N.A.	N.D.	
		DEHP	N.A.	N.D.	
DIBP	N.A.	N.D.			



Test Report

Report No.: 18360RC40003801

Page 88 of 135

Sample No.	Sample Description	Tested Items	XRF Screening Test Unit (mg/kg)	Chemical Test Unit (mg/kg)	Conclusion
256	Black heat thermal shrinkable sleeve	Pb	BL	/	PASS
		Cd	BL	/	
		Hg	BL	/	
		Cr(Cr(VI))	BL	/	
		Br(PBBs&PBDEs)	X	N.D.	
		DBP	N.A.	N.D.	
		BBP	N.A.	N.D.	
		DEHP	N.A.	N.D.	
257	Black plastic frame	Pb	BL	/	PASS
		Cd	BL	/	
		Hg	BL	/	
		Cr(Cr(VI))	BL	/	
		Br(PBBs&PBDEs)	X	N.D.	
		DBP	N.A.	N.D.	
		BBP	N.A.	N.D.	
		DEHP	N.A.	N.D.	
258	White label	Pb	BL	/	PASS
		Cd	BL	/	
		Hg	BL	/	
		Cr(Cr(VI))	BL	/	
		Br(PBBs&PBDEs)	BL	/	
		DBP	N.A.	N.D.	
		BBP	N.A.	N.D.	
		DEHP	N.A.	N.D.	
DIBP	N.A.	N.D.			



Test Report

Report No.: 18360RC40003801

Page 89 of 135

Sample No.	Sample Description	Tested Items	XRF Screening Test Unit (mg/kg)	Chemical Test Unit (mg/kg)	Conclusion
259	Silvery metal shell	Pb	BL	/	PASS
		Cd	BL	/	
		Hg	BL	/	
		Cr(Cr(VI))	X	Negative	
		Br(PBBs&PBDEs)	N.A.	/	
		DBP	N.A.	/	
		BBP	N.A.	/	
		DEHP	N.A.	/	
260	Silvery metal screw	Pb	BL	/	PASS
		Cd	BL	/	
		Hg	BL	/	
		Cr(Cr(VI))	BL	/	
		Br(PBBs&PBDEs)	N.A.	/	
		DBP	N.A.	/	
		BBP	N.A.	/	
		DEHP	N.A.	/	
261	White plastic jacket	Pb	BL	/	PASS
		Cd	BL	/	
		Hg	BL	/	
		Cr(Cr(VI))	BL	/	
		Br(PBBs&PBDEs)	BL	/	
		DBP	N.A.	N.D.	
		BBP	N.A.	N.D.	
		DEHP	N.A.	N.D.	
DIBP	N.A.	N.D.			



Test Report

Report No.: 18360RC40003801

Page 90 of 135

Sample No.	Sample Description	Tested Items	XRF Screening Test Unit (mg/kg)	Chemical Test Unit (mg/kg)	Conclusion
262	Silvery metal soldering tin	Pb	BL	/	PASS
		Cd	BL	/	
		Hg	BL	/	
		Cr(Cr(VI))	BL	/	
		Br(PBBs&PBDEs)	N.A.	/	
		DBP	N.A.	/	
		BBP	N.A.	/	
		DEHP	N.A.	/	
263	Chip resistor	Pb	BL	/	PASS
		Cd	BL	/	
		Hg	BL	/	
		Cr(Cr(VI))	BL	/	
		Br(PBBs&PBDEs)	BL	/	
		DBP	N.A.	N.D.	
		BBP	N.A.	N.D.	
		DEHP	N.A.	N.D.	
264	Copper-colored metal pillar	Pb	OL	33250*	PASS
		Cd	BL	/	
		Hg	BL	/	
		Cr(Cr(VI))	BL	/	
		Br(PBBs&PBDEs)	N.A.	/	
		DBP	N.A.	/	
		BBP	N.A.	/	
		DEHP	N.A.	/	
DIBP	N.A.	/			



Test Report

Report No.: 18360RC40003801

Page 91 of 135

Sample No.	Sample Description	Tested Items	XRF Screening Test Unit (mg/kg)	Chemical Test Unit (mg/kg)	Conclusion
265	IC	Pb	BL	/	PASS
		Cd	BL	/	
		Hg	BL	/	
		Cr(Cr(VI))	BL	/	
		Br(PBBs&PBDEs)	BL	/	
		DBP	N.A.	N.D.	
		BBP	N.A.	N.D.	
		DEHP	N.A.	N.D.	
266	Chip capacitor	Pb	BL	/	PASS
		Cd	BL	/	
		Hg	BL	/	
		Cr(Cr(VI))	BL	/	
		Br(PBBs&PBDEs)	BL	/	
		DBP	N.A.	N.D.	
		BBP	N.A.	N.D.	
		DEHP	N.A.	N.D.	
267	Copper-colored metal coil	Pb	BL	/	PASS
		Cd	BL	/	
		Hg	BL	/	
		Cr(Cr(VI))	BL	/	
		Br(PBBs&PBDEs)	N.A.	/	
		DBP	N.A.	/	
		BBP	N.A.	/	
		DEHP	N.A.	/	
DIBP	N.A.	/			



Test Report

Report No.: 18360RC40003801

Page 92 of 135

Sample No.	Sample Description	Tested Items	XRF Screening Test Unit (mg/kg)	Chemical Test Unit (mg/kg)	Conclusion
268	White plastic frame	Pb	BL	/	PASS
		Cd	BL	/	
		Hg	BL	/	
		Cr(Cr(VI))	BL	/	
		Br(PBBs&PBDEs)	BL	/	
		DBP	N.A.	N.D.	
		BBP	N.A.	N.D.	
		DEHP	N.A.	N.D.	
269	Green PCB board	Pb	BL	/	PASS
		Cd	BL	/	
		Hg	BL	/	
		Cr(Cr(VI))	BL	/	
		Br(PBBs&PBDEs)	X	N.D.	
		DBP	N.A.	N.D.	
		BBP	N.A.	N.D.	
		DEHP	N.A.	N.D.	
270	Black magnet circle	Pb	BL	/	PASS
		Cd	BL	/	
		Hg	BL	/	
		Cr(Cr(VI))	BL	/	
		Br(PBBs&PBDEs)	BL	/	
		DBP	N.A.	N.D.	
		BBP	N.A.	N.D.	
		DEHP	N.A.	N.D.	
DIBP	N.A.	N.D.			



Test Report

Report No.: 18360RC40003801

Page 93 of 135

Sample No.	Sample Description	Tested Items	XRF Screening Test Unit (mg/kg)	Chemical Test Unit (mg/kg)	Conclusion
271	Silvery metal spring	Pb	BL	/	PASS
		Cd	BL	/	
		Hg	BL	/	
		Cr(Cr(VI))	BL	/	
		Br(PBBs&PBDEs)	N.A.	/	
		DBP	N.A.	/	
		BBP	N.A.	/	
		DEHP	N.A.	/	
		DIBP	N.A.	/	
272	Silvery metal bearing	Pb	BL	/	PASS
		Cd	BL	/	
		Hg	BL	/	
		Cr(Cr(VI))	BL	/	
		Br(PBBs&PBDEs)	N.A.	/	
		DBP	N.A.	/	
		BBP	N.A.	/	
		DEHP	N.A.	/	
		DIBP	N.A.	/	
273	Silvery metal shell	Pb	BL	/	PASS
		Cd	BL	/	
		Hg	BL	/	
		Cr(Cr(VI))	BL	/	
		Br(PBBs&PBDEs)	N.A.	/	
		DBP	N.A.	/	
		BBP	N.A.	/	
		DEHP	N.A.	/	
		DIBP	N.A.	/	



Test Report

Report No.: 18360RC40003801

Page 94 of 135

Sample No.	Sample Description	Tested Items	XRF Screening Test Unit (mg/kg)	Chemical Test Unit (mg/kg)	Conclusion
274	Black plastic shell	Pb	BL	/	PASS
		Cd	BL	/	
		Hg	BL	/	
		Cr(Cr(VI))	BL	/	
		Br(PBBs&PBDEs)	X	N.D.	
		DBP	N.A.	N.D.	
		BBP	N.A.	N.D.	
		DEHP	N.A.	N.D.	
275	Silvery metal screw	Pb	BL	/	PASS
		Cd	BL	/	
		Hg	BL	/	
		Cr(Cr(VI))	BL	/	
		Br(PBBs&PBDEs)	N.A.	/	
		DBP	N.A.	/	
		BBP	N.A.	/	
		DEHP	N.A.	/	
276	Metal screw with black coating	Pb	BL	/	PASS
		Cd	BL	/	
		Hg	BL	/	
		Cr(Cr(VI))	BL	/	
		Br(PBBs&PBDEs)	N.A.	/	
		DBP	N.A.	/	
		BBP	N.A.	/	
		DEHP	N.A.	/	
DIBP	N.A.	/			



Test Report

Report No.: 18360RC40003801

Page 95 of 135

Sample No.	Sample Description	Tested Items	XRF Screening Test Unit (mg/kg)	Chemical Test Unit (mg/kg)	Conclusion
277	Metal screw with black coating	Pb	BL	/	PASS
		Cd	BL	/	
		Hg	BL	/	
		Cr(Cr(VI))	BL	/	
		Br(PBBs&PBDEs)	N.A.	/	
		DBP	N.A.	/	
		BBP	N.A.	/	
		DEHP	N.A.	/	
278	Silvery metal ring	Pb	BL	/	PASS
		Cd	BL	/	
		Hg	BL	/	
		Cr(Cr(VI))	BL	/	
		Br(PBBs&PBDEs)	N.A.	/	
		DBP	N.A.	/	
		BBP	N.A.	/	
		DEHP	N.A.	/	
279	Silvery metal screw	Pb	BL	/	PASS
		Cd	BL	/	
		Hg	BL	/	
		Cr(Cr(VI))	BL	/	
		Br(PBBs&PBDEs)	N.A.	/	
		DBP	N.A.	/	
		BBP	N.A.	/	
		DEHP	N.A.	/	
		DIBP	N.A.	/	



Test Report

Report No.: 18360RC40003801

Page 96 of 135

Sample No.	Sample Description	Tested Items	XRF Screening Test Unit (mg/kg)	Chemical Test Unit (mg/kg)	Conclusion
280	Silvery metal gasket	Pb	BL	/	PASS
		Cd	BL	/	
		Hg	BL	/	
		Cr(Cr(VI))	BL	/	
		Br(PBBs&PBDEs)	N.A.	/	
		DBP	N.A.	/	
		BBP	N.A.	/	
		DEHP	N.A.	/	
281	Silvery metal screw	Pb	BL	/	PASS
		Cd	BL	/	
		Hg	BL	/	
		Cr(Cr(VI))	BL	/	
		Br(PBBs&PBDEs)	N.A.	/	
		DBP	N.A.	/	
		BBP	N.A.	/	
		DEHP	N.A.	/	
282	Silvery metal screw	Pb	BL	/	PASS
		Cd	BL	/	
		Hg	BL	/	
		Cr(Cr(VI))	BL	/	
		Br(PBBs&PBDEs)	N.A.	/	
		DBP	N.A.	/	
		BBP	N.A.	/	
		DEHP	N.A.	/	
		DIBP	N.A.	/	



Test Report

Report No.: 18360RC40003801

Page 97 of 135

Sample No.	Sample Description	Tested Items	XRF Screening Test Unit (mg/kg)	Chemical Test Unit (mg/kg)	Conclusion
283	Silvery metal sheet	Pb	BL	/	PASS
		Cd	BL	/	
		Hg	BL	/	
		Cr(Cr(VI))	BL	/	
		Br(PBBs&PBDEs)	N.A.	/	
		DBP	N.A.	/	
		BBP	N.A.	/	
		DEHP	N.A.	/	
284	Black plastic jacket	Pb	BL	/	PASS
		Cd	BL	/	
		Hg	BL	/	
		Cr(Cr(VI))	BL	/	
		Br(PBBs&PBDEs)	BL	/	
		DBP	N.A.	N.D.	
		BBP	N.A.	N.D.	
		DEHP	N.A.	N.D.	
285	Red plastic jacket	Pb	BL	/	PASS
		Cd	BL	/	
		Hg	BL	/	
		Cr(Cr(VI))	BL	/	
		Br(PBBs&PBDEs)	BL	/	
		DBP	N.A.	N.D.	
		BBP	N.A.	N.D.	
		DEHP	N.A.	N.D.	
DIBP	N.A.	N.D.			



Test Report

Report No.: 18360RC40003801

Page 98 of 135

Sample No.	Sample Description	Tested Items	XRF Screening Test Unit (mg/kg)	Chemical Test Unit (mg/kg)	Conclusion
286	Silvery metal sheet	Pb	BL	/	PASS
		Cd	BL	/	
		Hg	BL	/	
		Cr(Cr(VI))	BL	/	
		Br(PBBs&PBDEs)	N.A.	/	
		DBP	N.A.	/	
		BBP	N.A.	/	
		DEHP	N.A.	/	
287	Black heat thermal shrinkable sleeve	Pb	BL	/	PASS
		Cd	BL	/	
		Hg	BL	/	
		Cr(Cr(VI))	BL	/	
		Br(PBBs&PBDEs)	BL	/	
		DBP	N.A.	N.D.	
		BBP	N.A.	N.D.	
		DEHP	N.A.	N.D.	
288	Black plastic cable tie	Pb	BL	/	PASS
		Cd	BL	/	
		Hg	BL	/	
		Cr(Cr(VI))	BL	/	
		Br(PBBs&PBDEs)	BL	/	
		DBP	N.A.	N.D.	
		BBP	N.A.	N.D.	
		DEHP	N.A.	N.D.	
DIBP	N.A.	N.D.			



Test Report

Report No.: 18360RC40003801

Page 99 of 135

Sample No.	Sample Description	Tested Items	XRF Screening Test Unit (mg/kg)	Chemical Test Unit (mg/kg)	Conclusion
289	Orange yellow plastic shell	Pb	BL	/	PASS
		Cd	BL	/	
		Hg	BL	/	
		Cr(Cr(VI))	BL	/	
		Br(PBBs&PBDEs)	X	N.D.	
		DBP	N.A.	N.D.	
		BBP	N.A.	N.D.	
		DEHP	N.A.	N.D.	
290	Silvery metal plug	Pb	BL	/	PASS
		Cd	BL	/	
		Hg	BL	/	
		Cr(Cr(VI))	BL	/	
		Br(PBBs&PBDEs)	N.A.	/	
		DBP	N.A.	/	
		BBP	N.A.	/	
		DEHP	N.A.	/	
291	Orange yellow plastic shell	Pb	BL	/	PASS
		Cd	BL	/	
		Hg	BL	/	
		Cr(Cr(VI))	BL	/	
		Br(PBBs&PBDEs)	X	N.D.	
		DBP	N.A.	N.D.	
		BBP	N.A.	N.D.	
		DEHP	N.A.	N.D.	
DIBP	N.A.	N.D.			



Test Report

Report No.: 18360RC40003801

Page 100 of 135

Sample No.	Sample Description	Tested Items	XRF Screening Test Unit (mg/kg)	Chemical Test Unit (mg/kg)	Conclusion
292	Silvery metal socket	Pb	BL	/	PASS
		Cd	BL	/	
		Hg	BL	/	
		Cr(Cr(VI))	BL	/	
		Br(PBBs&PBDEs)	N.A.	/	
		DBP	N.A.	/	
		BBP	N.A.	/	
		DEHP	N.A.	/	
293	Black rubber block	Pb	BL	/	PASS
		Cd	BL	/	
		Hg	BL	/	
		Cr(Cr(VI))	BL	/	
		Br(PBBs&PBDEs)	BL	/	
		DBP	N.A.	N.D.	
		BBP	N.A.	N.D.	
		DEHP	N.A.	N.D.	
294	Silvery conductive cotton	Pb	BL	/	PASS
		Cd	BL	/	
		Hg	BL	/	
		Cr(Cr(VI))	BL	/	
		Br(PBBs&PBDEs)	BL	/	
		DBP	N.A.	N.D.	
		BBP	N.A.	N.D.	
		DEHP	N.A.	N.D.	
DIBP	N.A.	N.D.			



Test Report

Report No.: 18360RC40003801

Page 101 of 135

Sample No.	Sample Description	Tested Items	XRF Screening Test Unit (mg/kg)	Chemical Test Unit (mg/kg)	Conclusion
295	Silvery conductive cotton	Pb	BL	/	PASS
		Cd	BL	/	
		Hg	BL	/	
		Cr(Cr(VI))	BL	/	
		Br(PBBs&PBDEs)	BL	/	
		DBP	N.A.	N.D.	
		BBP	N.A.	N.D.	
		DEHP	N.A.	N.D.	
		DIBP	N.A.	N.D.	
296	Black sponge sheet	Pb	BL	/	PASS
		Cd	BL	/	
		Hg	BL	/	
		Cr(Cr(VI))	BL	/	
		Br(PBBs&PBDEs)	BL	/	
		DBP	N.A.	N.D.	
		BBP	N.A.	N.D.	
		DEHP	N.A.	N.D.	
		DIBP	N.A.	N.D.	



Test Report

Report No.: 18360RC40003801

Page 102 of 135

Note:

- The screening results are only used for reference.
 - When conducting the test for PBBs&PBDEs, XRF was introduced to screen Br Exclusively; When conducting the test for Hexavalent Chromium, XRF was introduced to screen Chromium exclusively.
 - BL = Under the XRF screening limit
 - OL = Further chemical test will be conducted while result is above the screening limit
 - X= The symbol "X" marks the region where further investigation is necessary
 - LOD= Detection limit
 - MDL = Method Detection Limit
 - N.A. = Not Applicable
 - N.D. = Not Detected (<MDL)
 - /=Not tested
 - 1mg/kg = 1ppm = 0.0001%
 - $\mu\text{g}/\text{cm}^2$ = microgramme per square centimeter
 - "---"=
- a. -Negative = Absence of Cr(VI) , the detected Cr(VI) concentration in the boiling water extraction solution is less than $0.10\mu\text{g}/\text{cm}^2$.
 - b. -Positive = Presence of Cr(VI), the detected Cr(VI) concentration in the boiling water extraction solution is greater than $0.13\mu\text{g}/\text{cm}^2$.
 - c. The result is between $0.10\mu\text{g}/\text{cm}^2$ with $0.13\mu\text{g}/\text{cm}^2$ is considered to be inconclusive-unavoidable coating variations may influence the determination.
- *=According to the client's statement, the material of the sample(s) falls into exemption items 6(c) according to EU RoHS Directive 2011/65/EU: Copper alloy containing up to 4% Lead by weight.



Test Report

Report No.: 18360RC40003801

Page 103 of 135

Test Process:

The sample(s) had been dissolved totally tested for Lead, Cadmium, Mercury.

◆ IEC 62321-5:2013

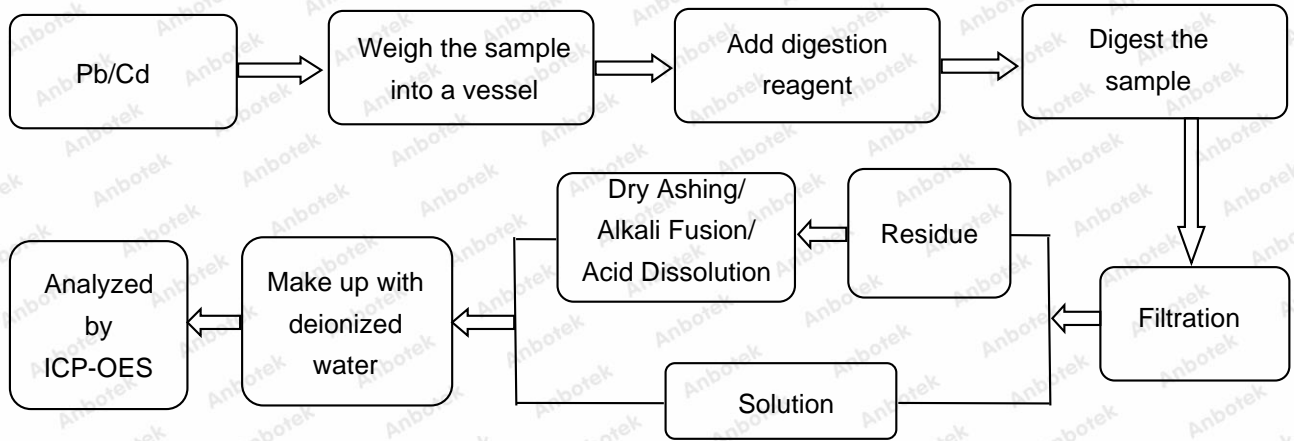

◆ IEC 62321-4:2013+AMD1:2017

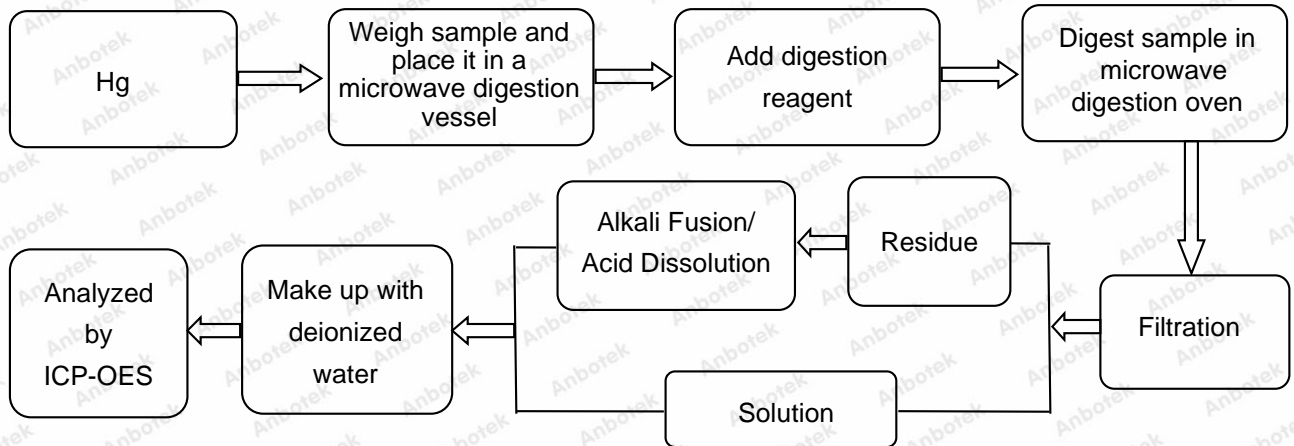

Test Report

Report No.: 18360RC40003801

Page 104 of 135

◆ IEC 62321-7-1:2015

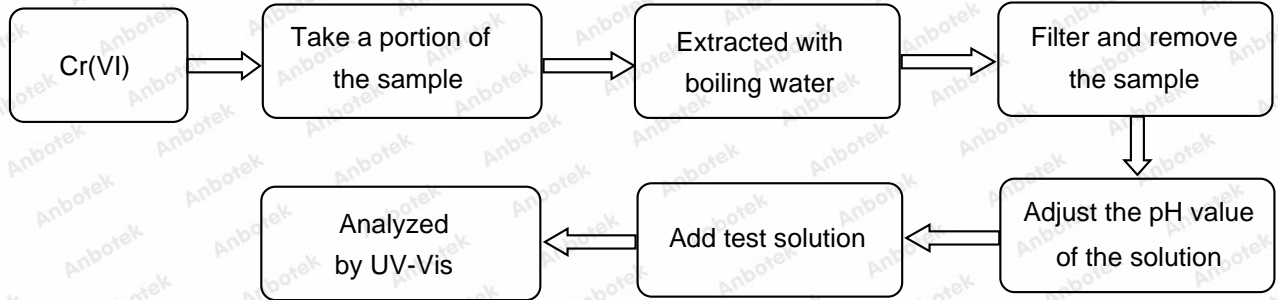

◆ IEC 62321-7-2:2017

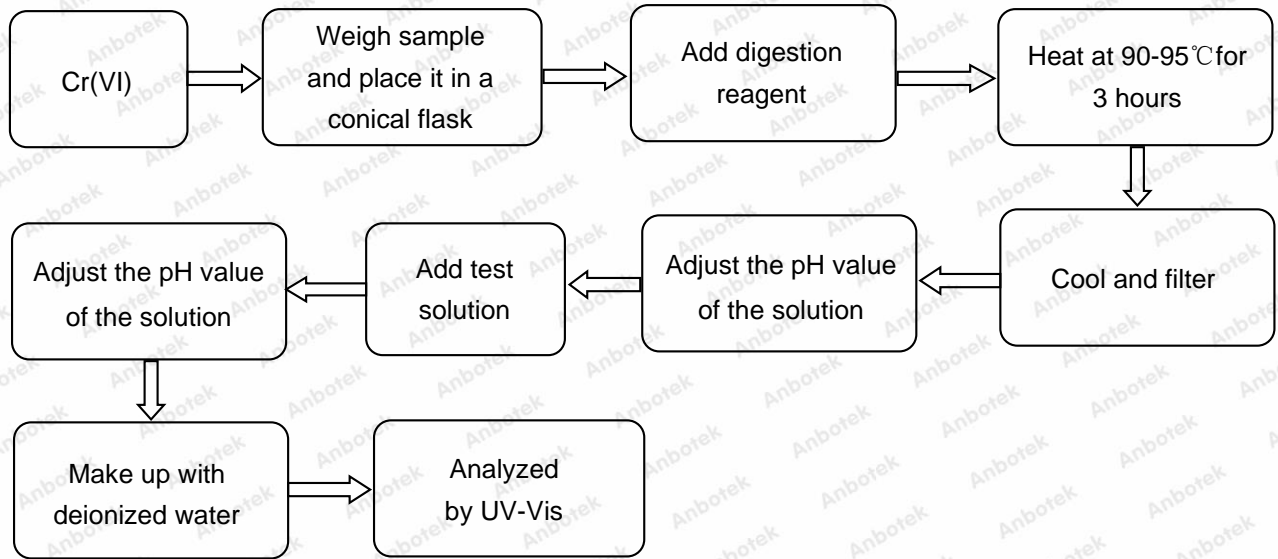

Test Report

Report No.: 18360RC40003801

Page 105 of 135

◆ IEC 62321-6:2015

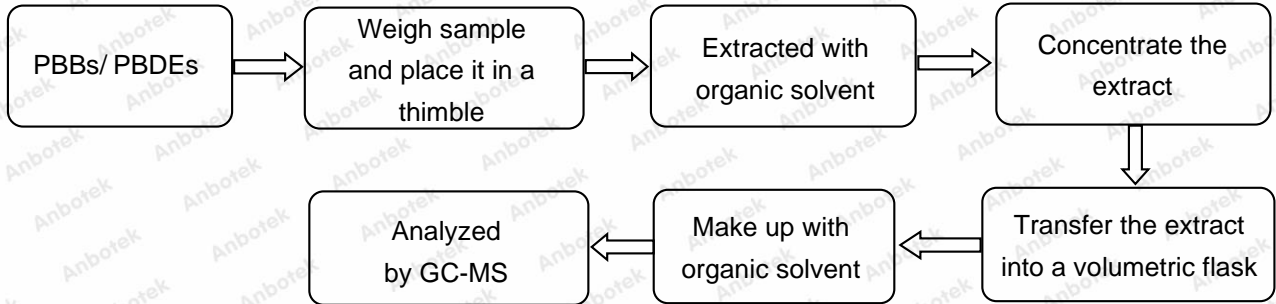

◆ IEC 62321-8:2017

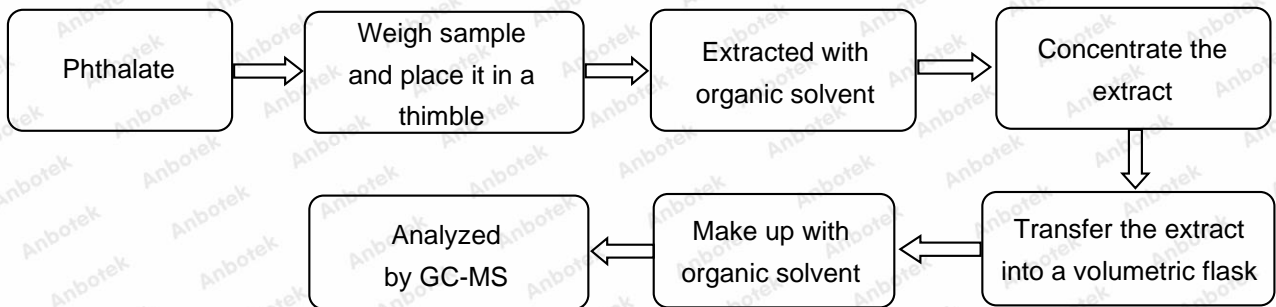

Test Report

Report No.: 18360RC40003801

Page 106 of 135

Photograph of Sample

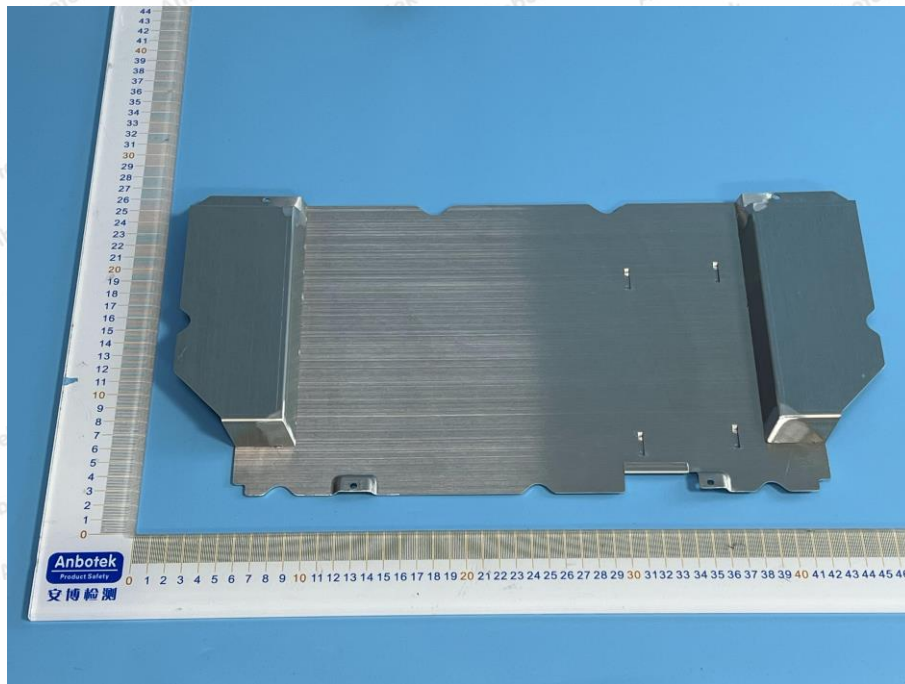

Test Report

Report No.: 18360RC40003801

Page 107 of 135



Photo(s) of the tested component(s)



Test Report

Report No.: 18360RC40003801

Page 108 of 135

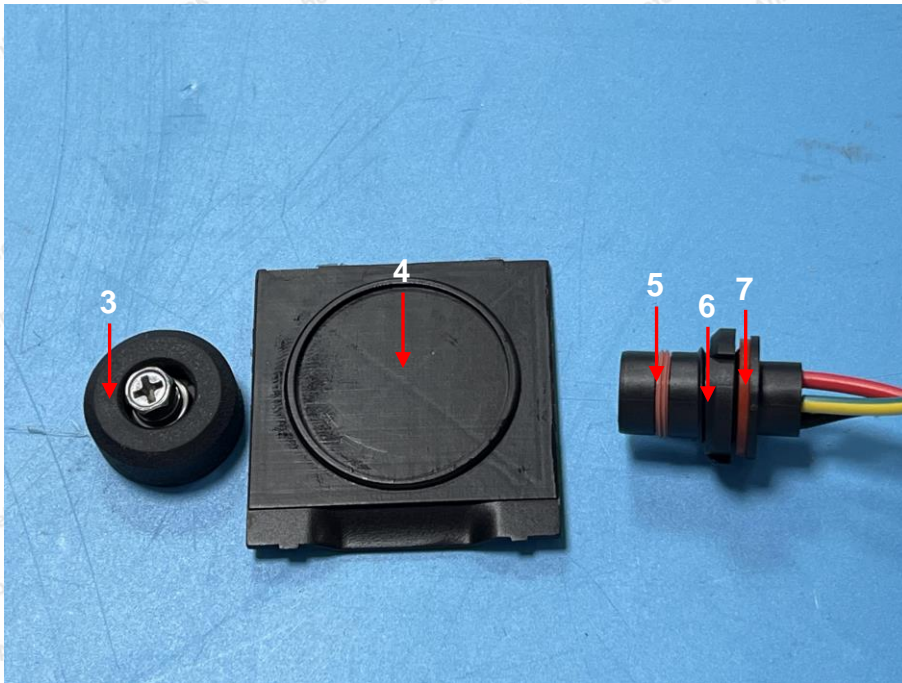
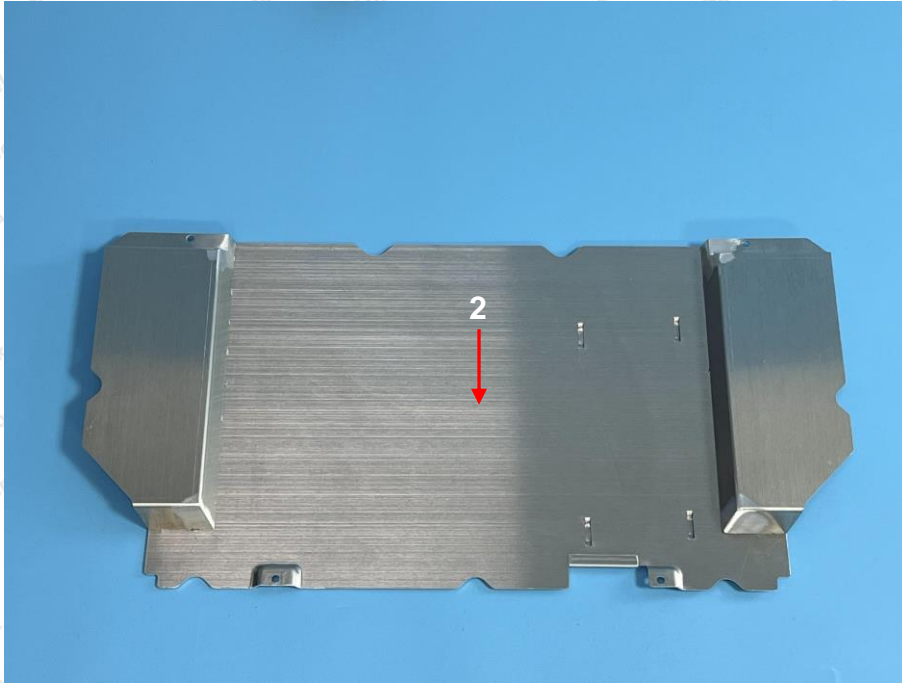

Test Report

Report No.: 18360RC40003801

Page 109 of 135

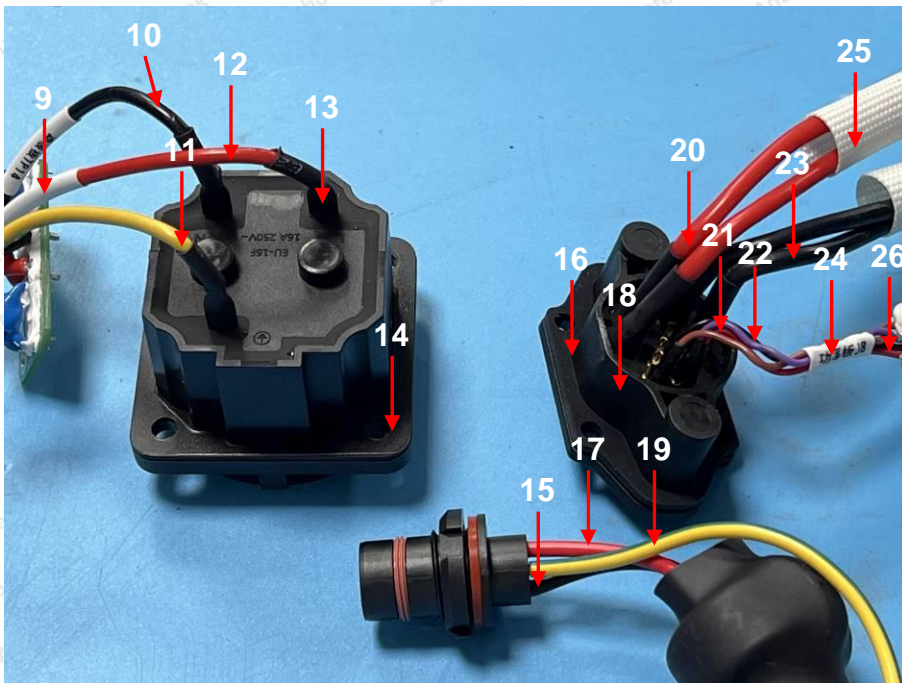

Test Report

Report No.: 18360RC40003801

Page 110 of 135

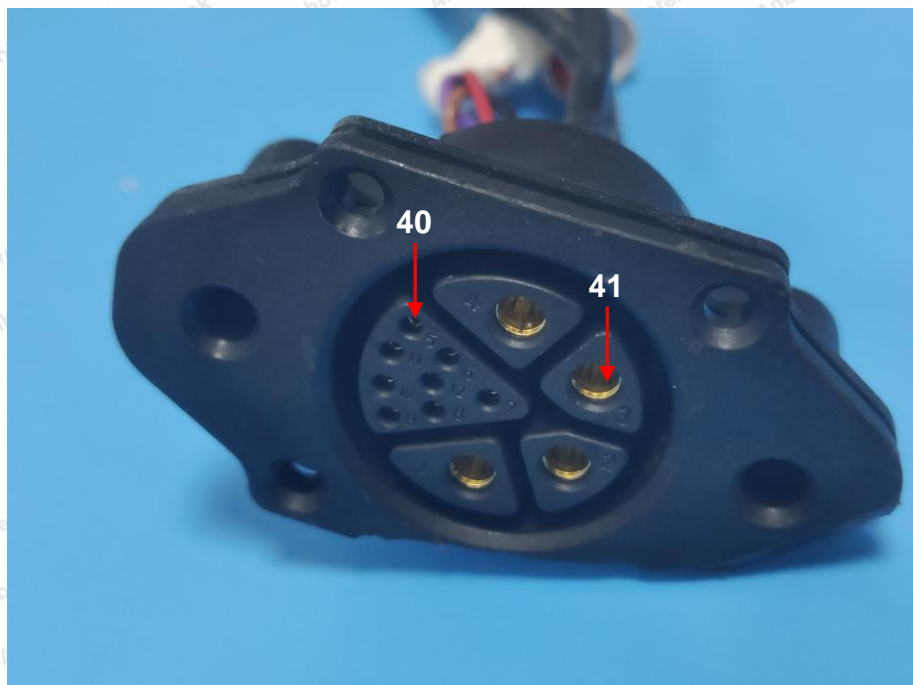
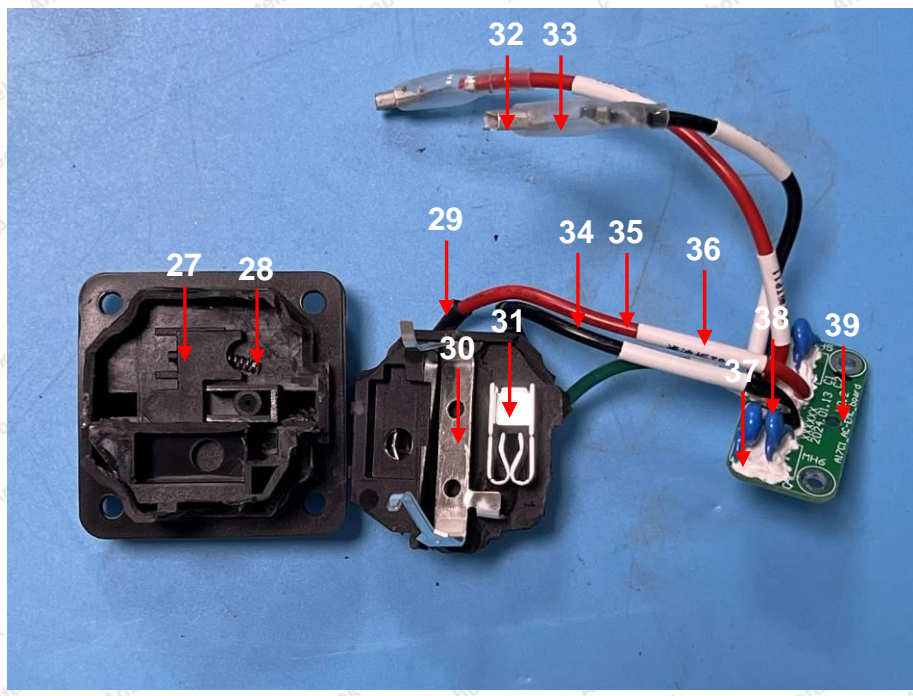

Test Report

Report No.: 18360RC40003801

Page 111 of 135

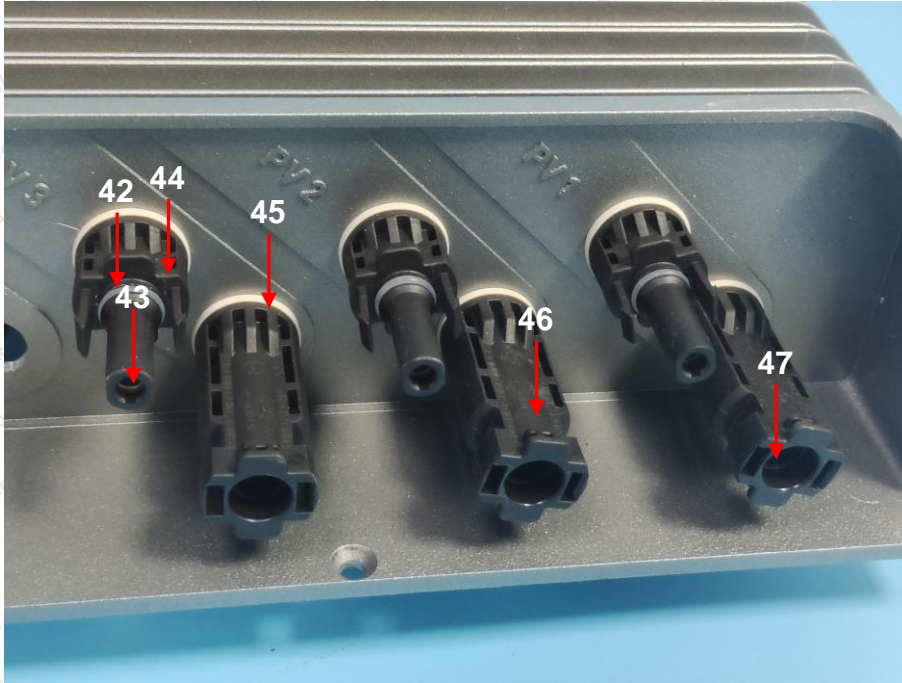

Test Report

Report No.: 18360RC40003801

Page 112 of 135

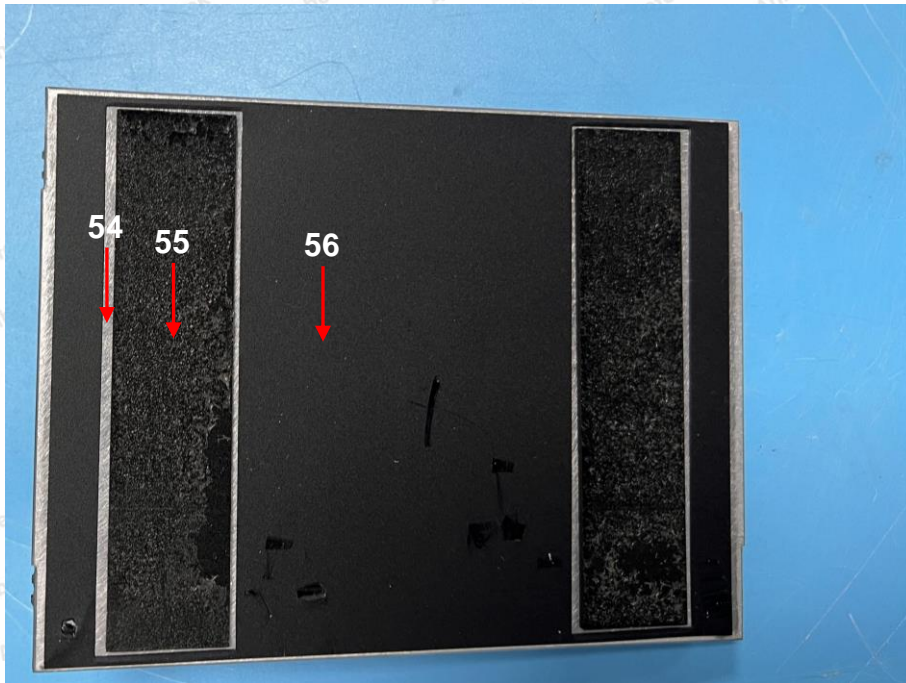
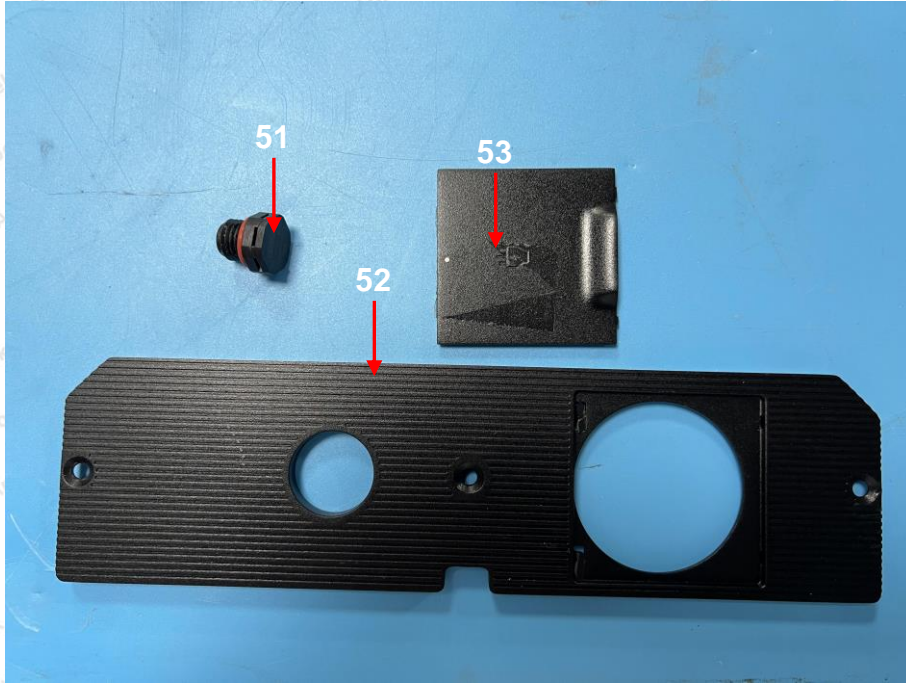

Test Report

Report No.: 18360RC40003801

Page 113 of 135

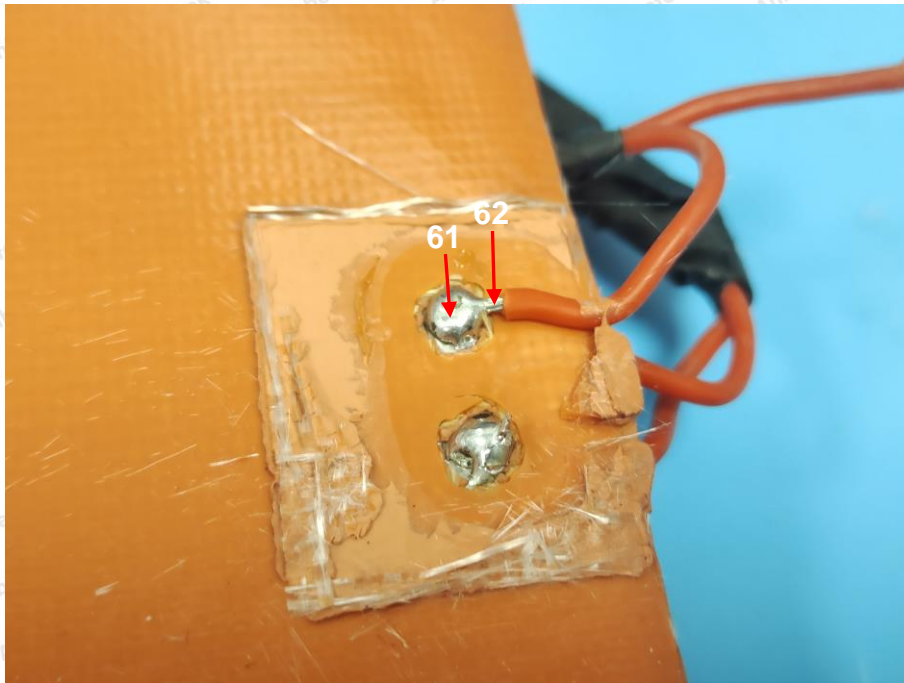
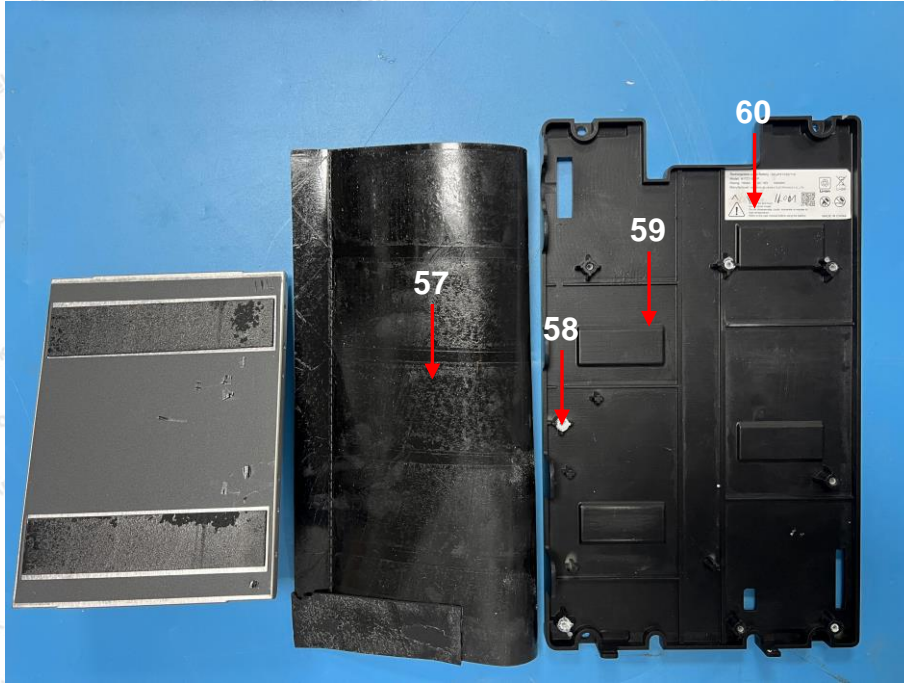

Test Report

Report No.: 18360RC40003801

Page 114 of 135

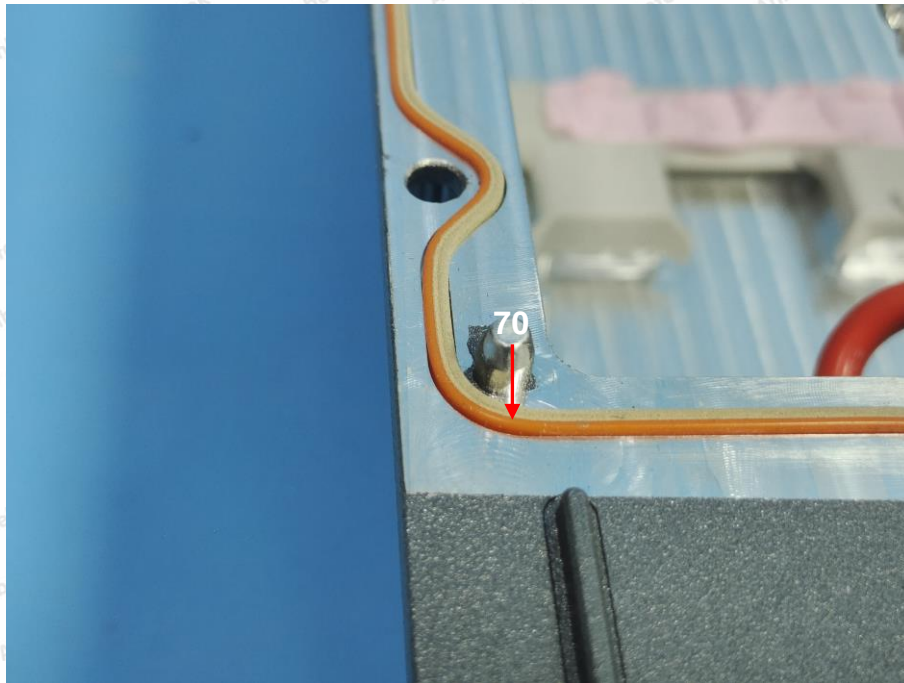
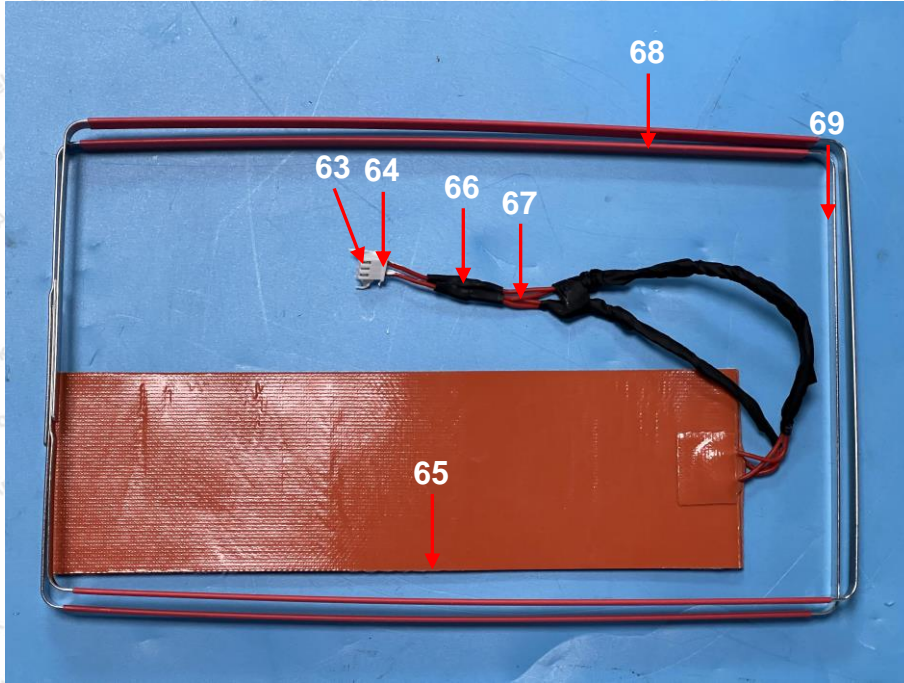

Test Report

Report No.: 18360RC40003801

Page 115 of 135

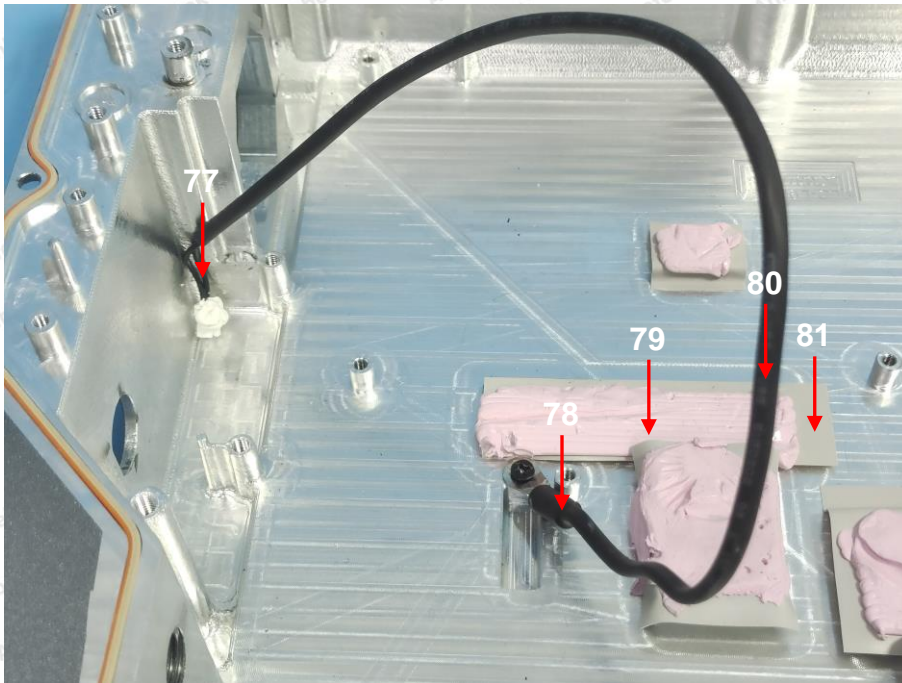
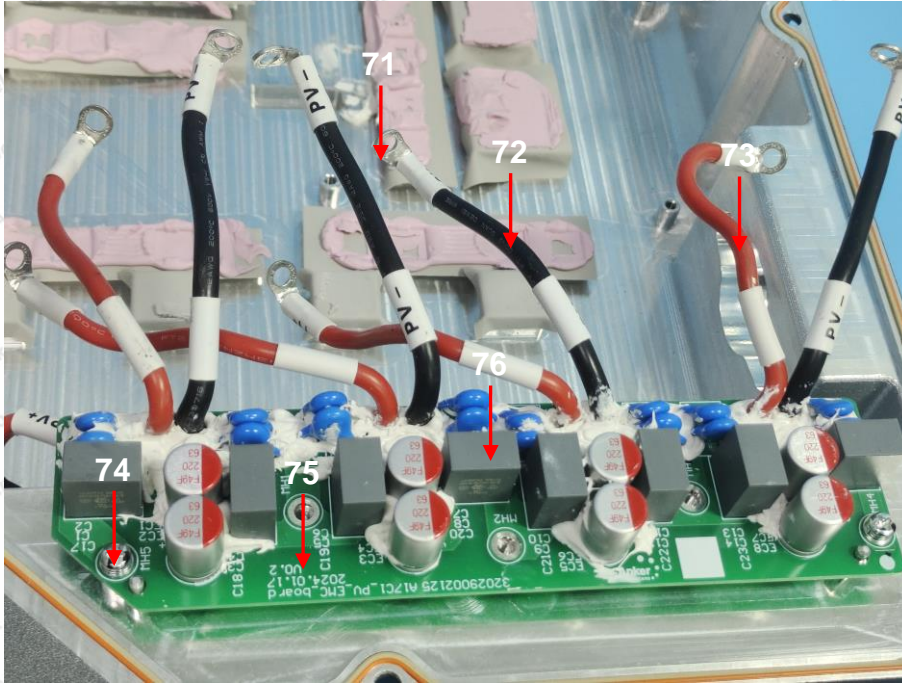

Test Report

Report No.: 18360RC40003801

Page 116 of 135

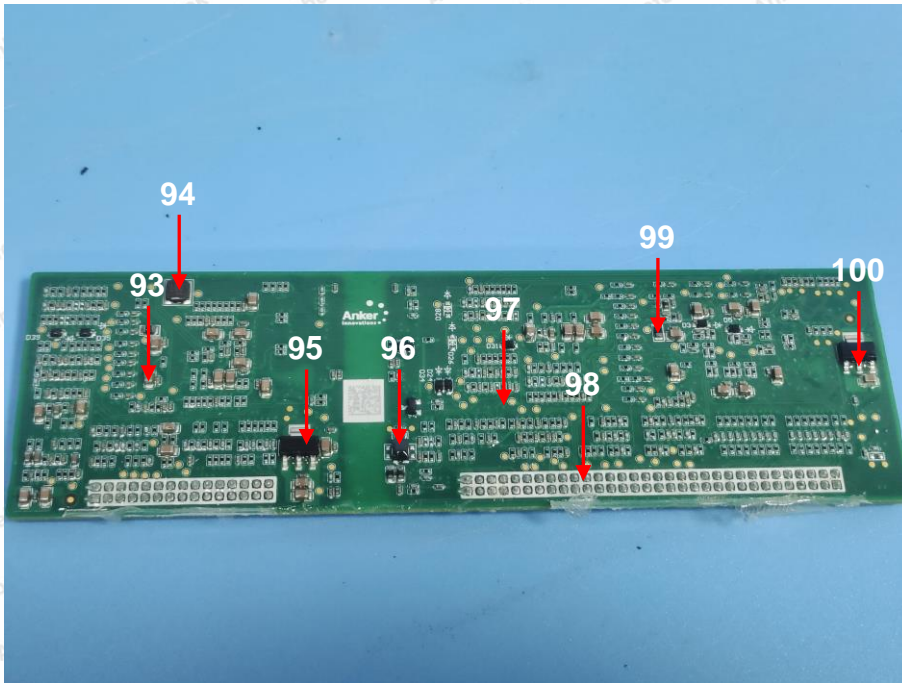
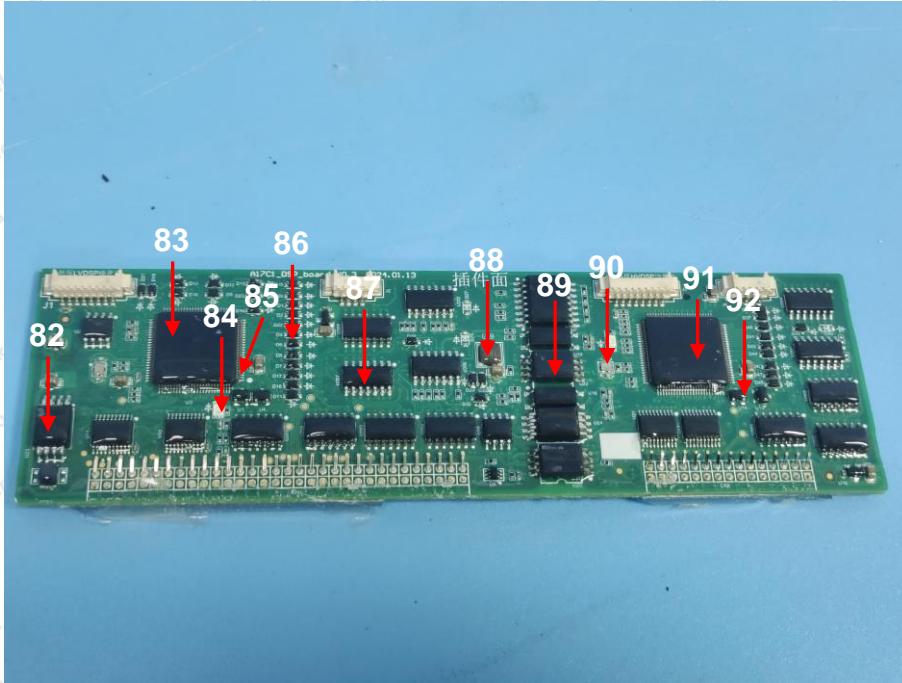

Test Report

Report No.: 18360RC40003801

Page 117 of 135

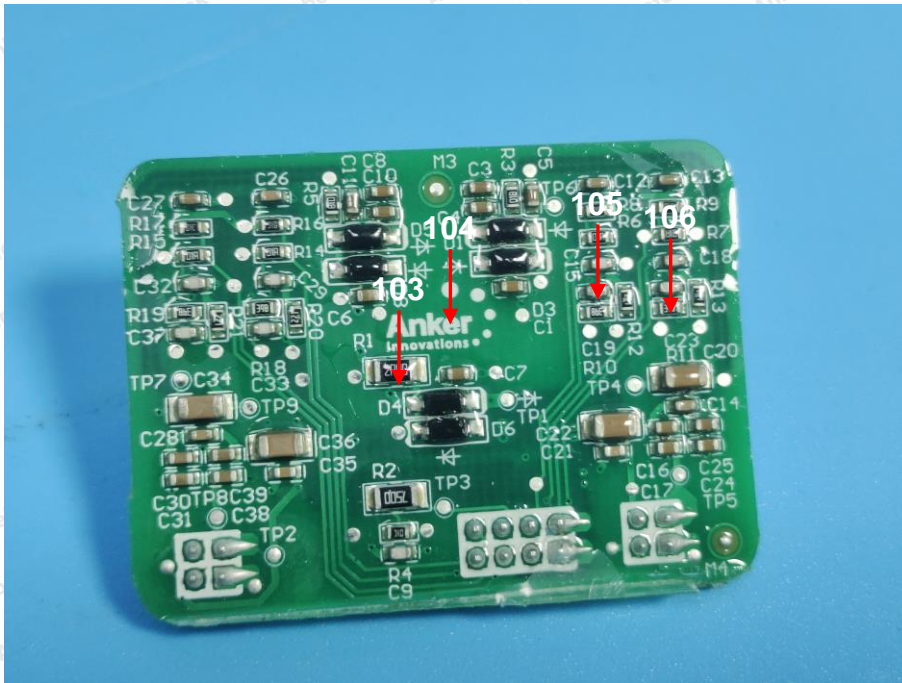
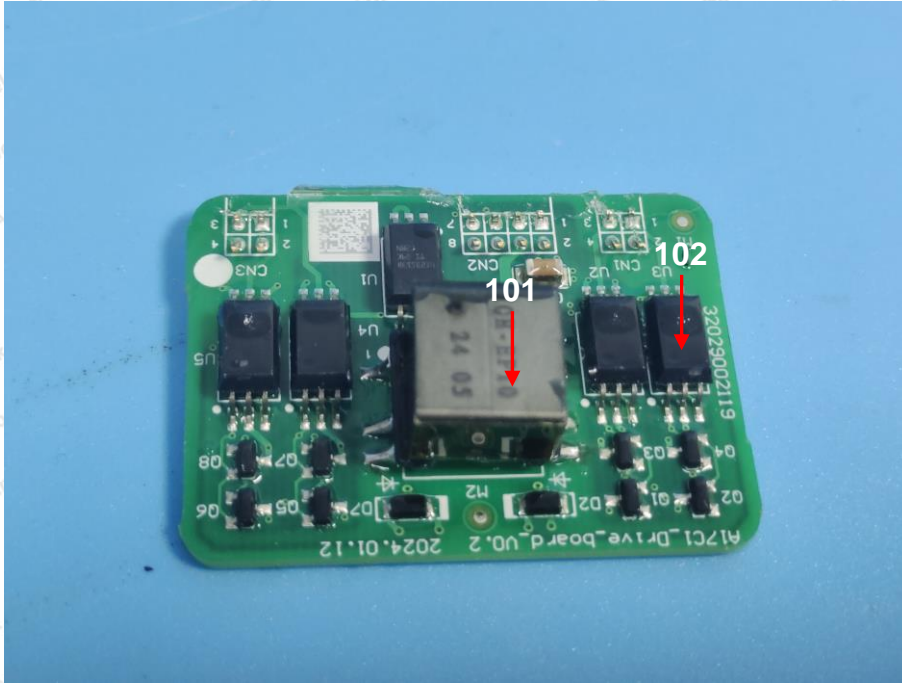

Test Report

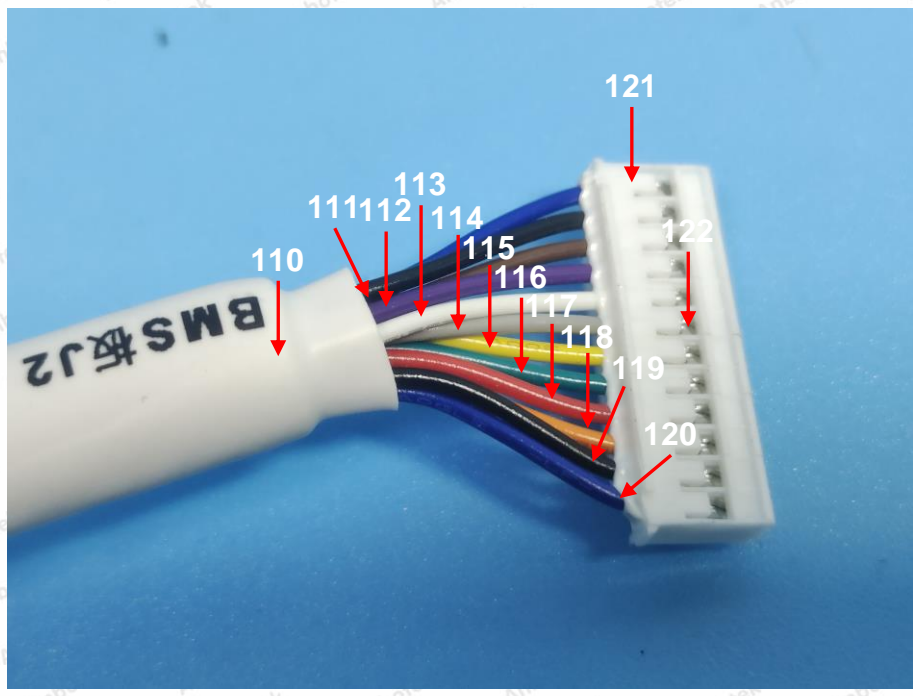
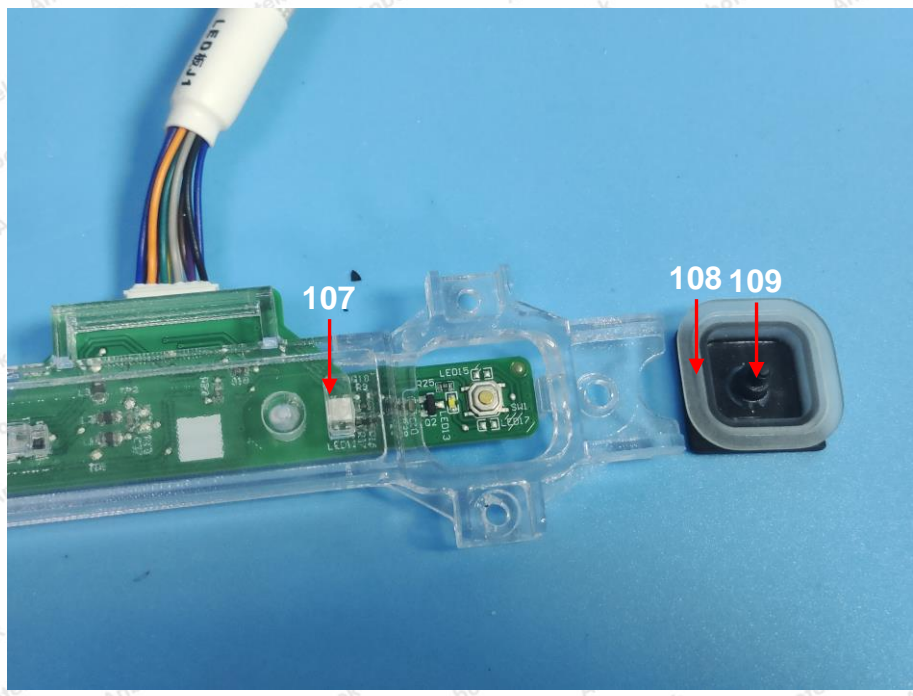

Test Report

Report No.: 18360RC40003801

Page 119 of 135

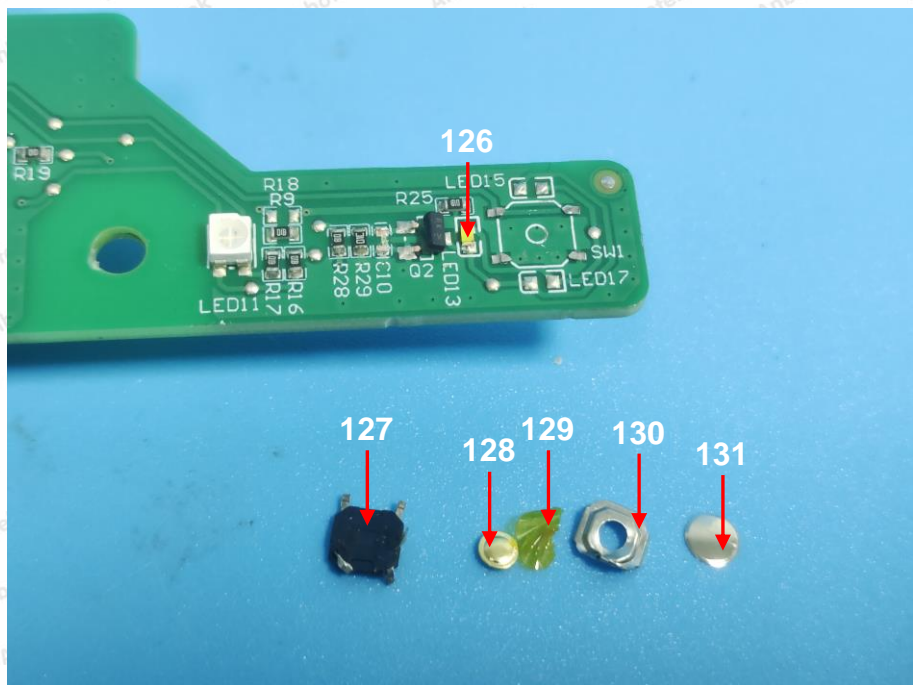
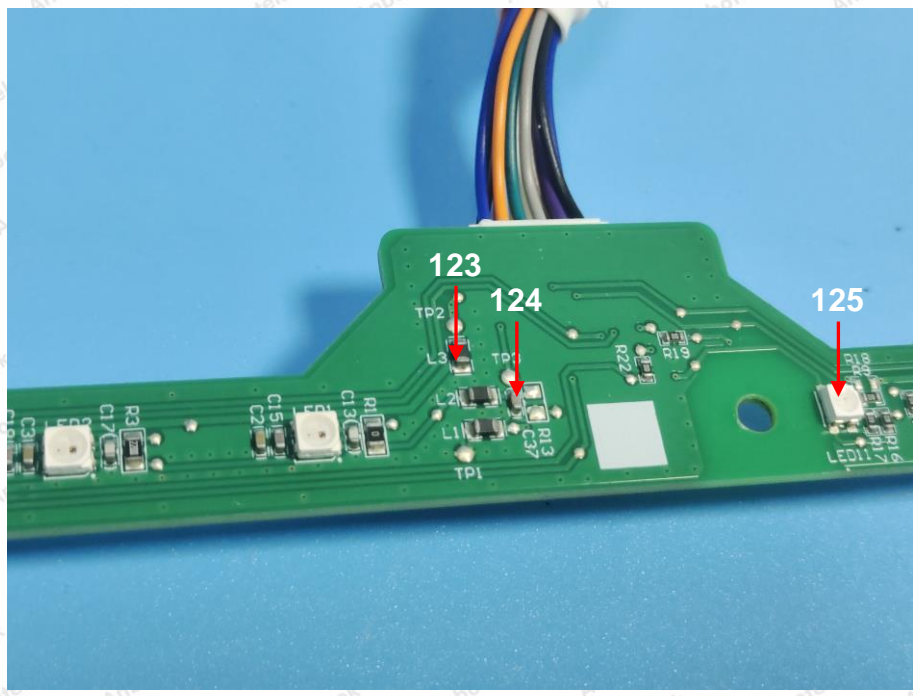

Test Report

Report No.: 18360RC40003801

Page 120 of 135

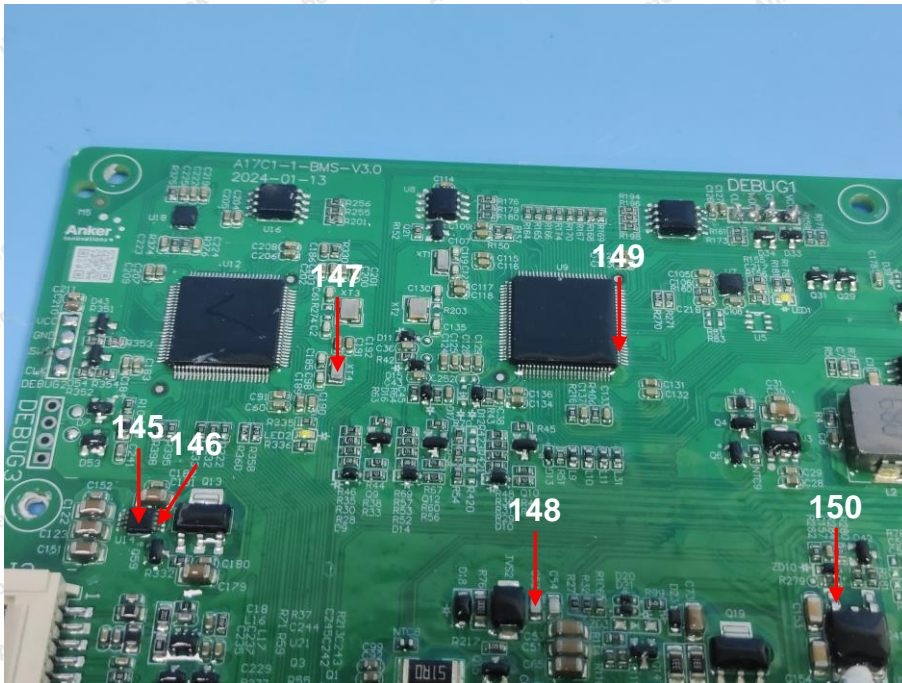
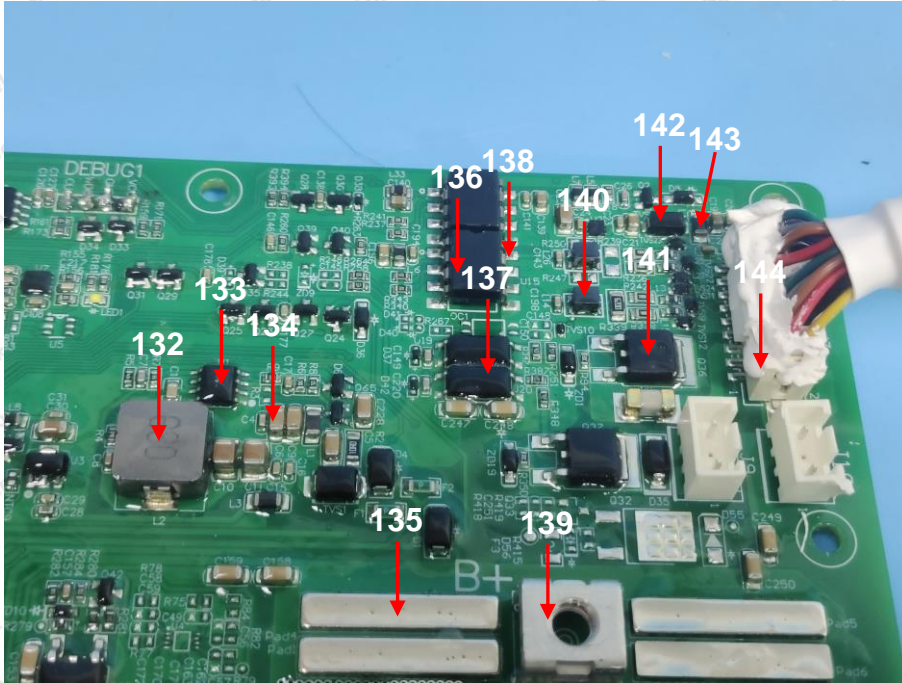

Test Report

Report No.: 18360RC40003801

Page 121 of 135

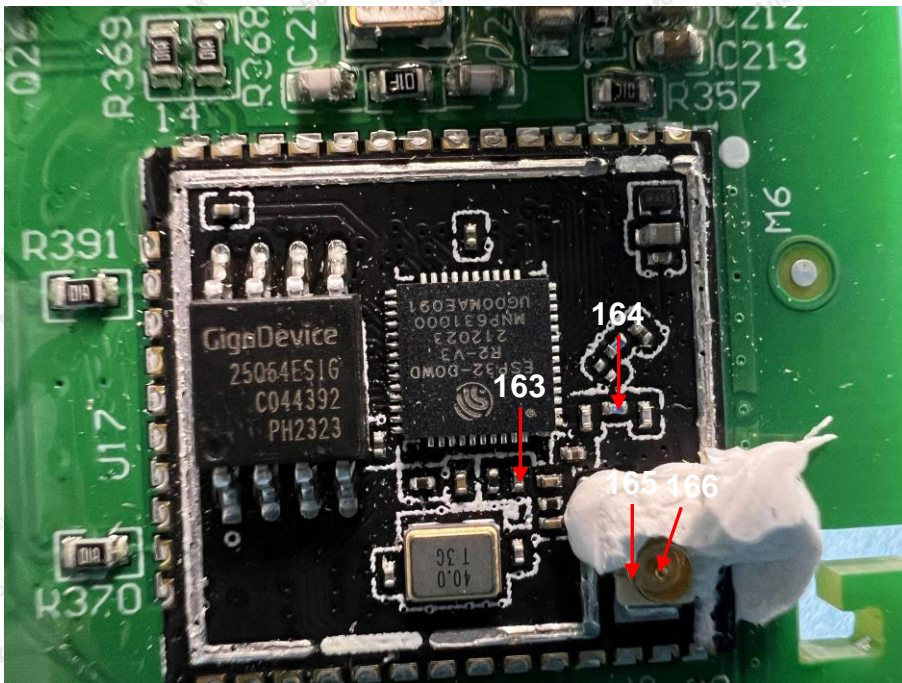
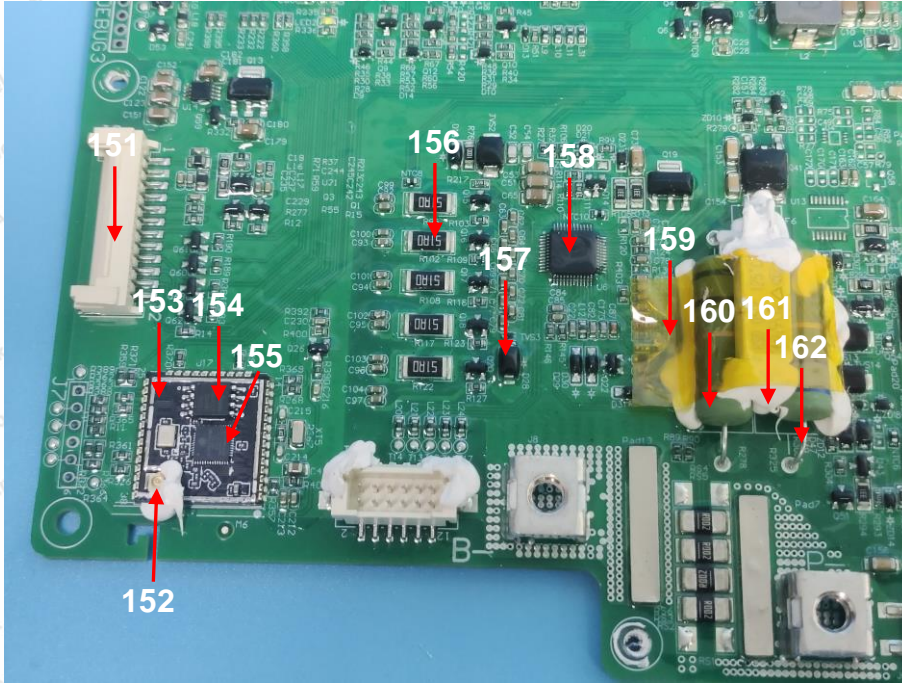

Test Report

Report No.: 18360RC40003801

Page 122 of 135

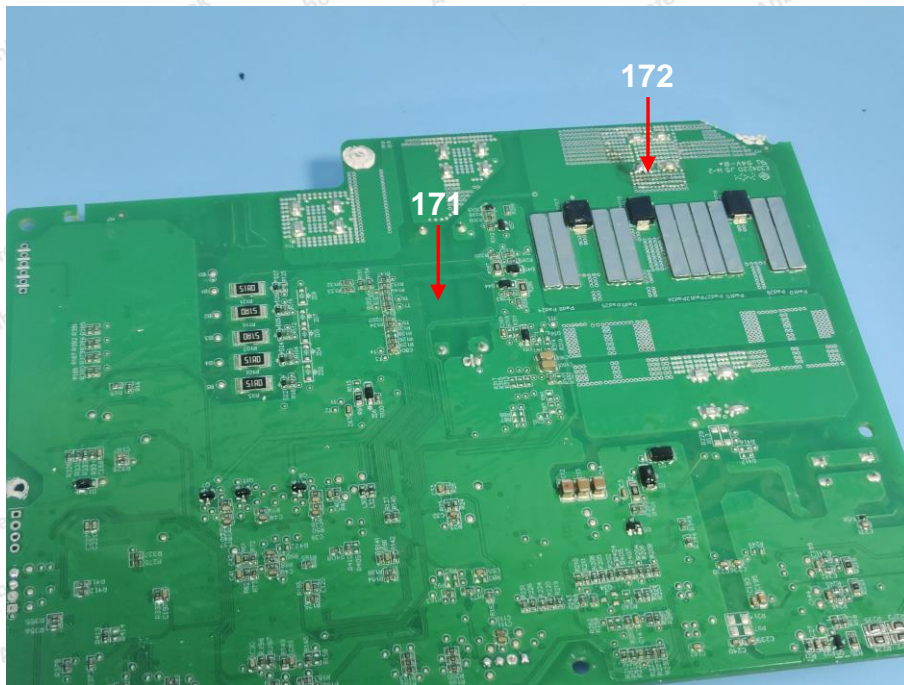
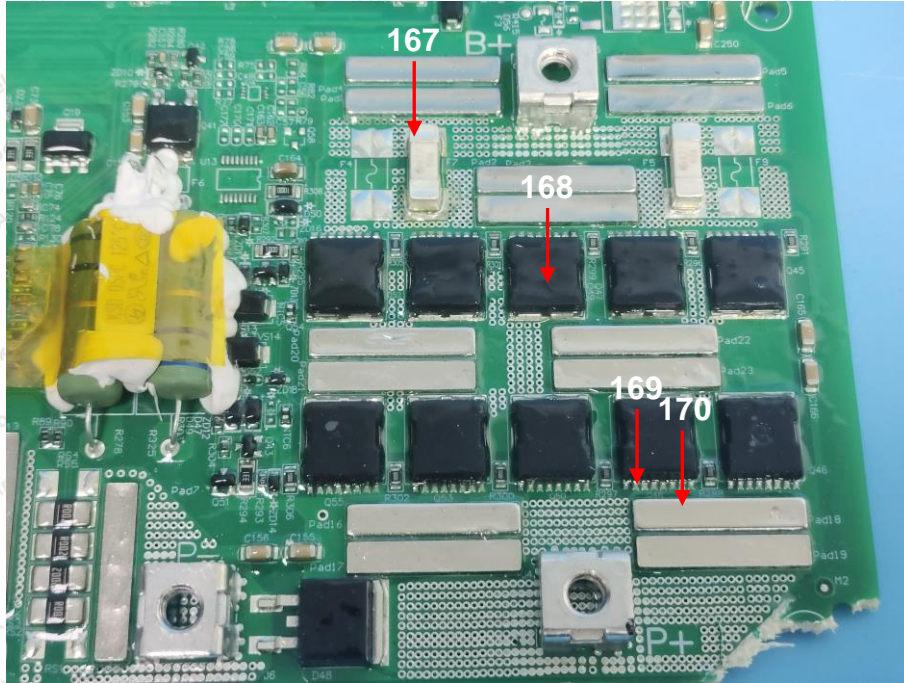

Test Report

Report No.: 18360RC40003801

Page 123 of 135

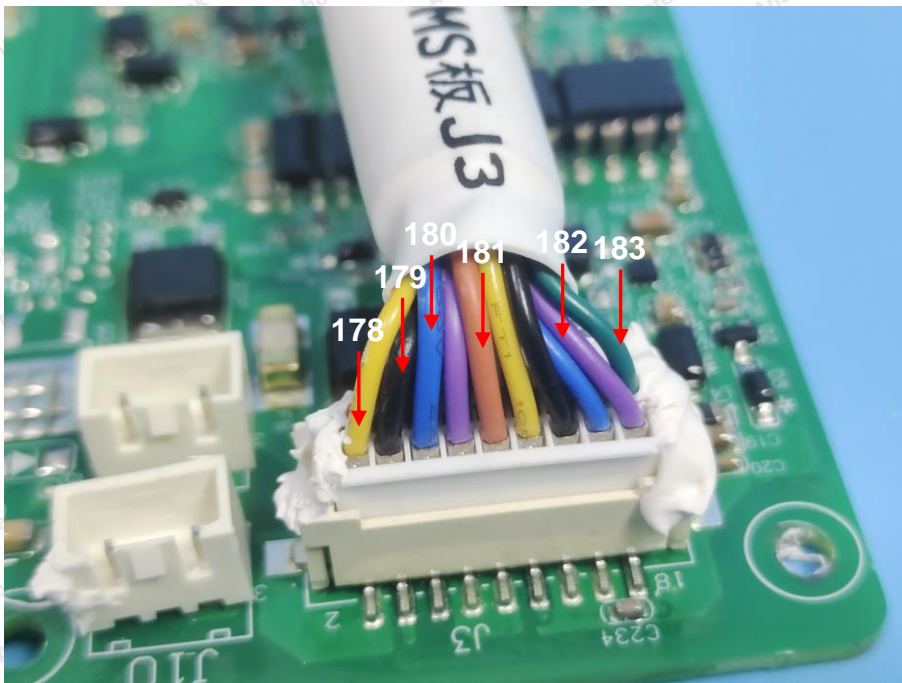
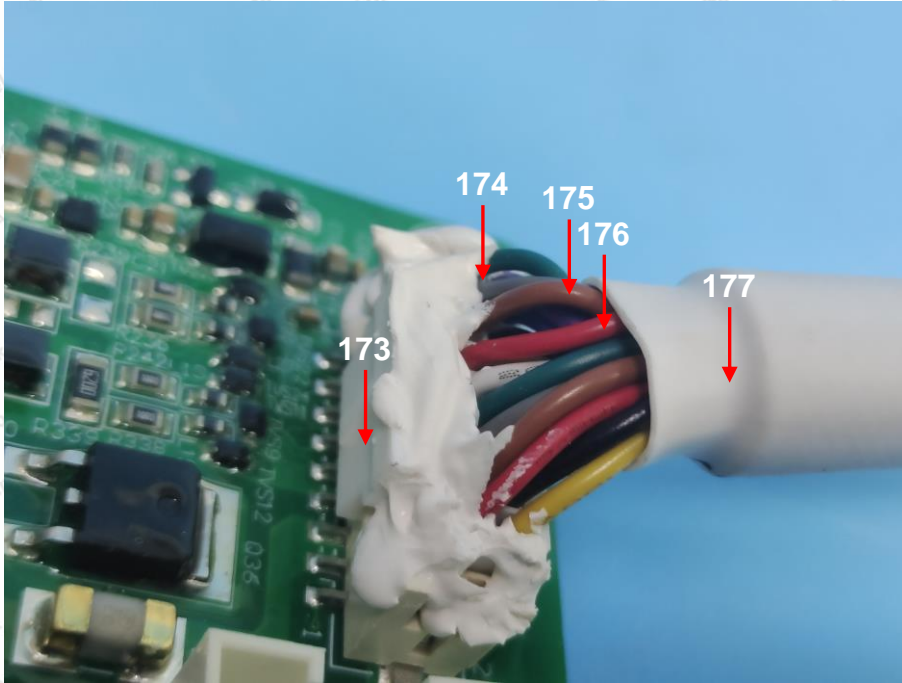

Test Report

Report No.: 18360RC40003801

Page 124 of 135

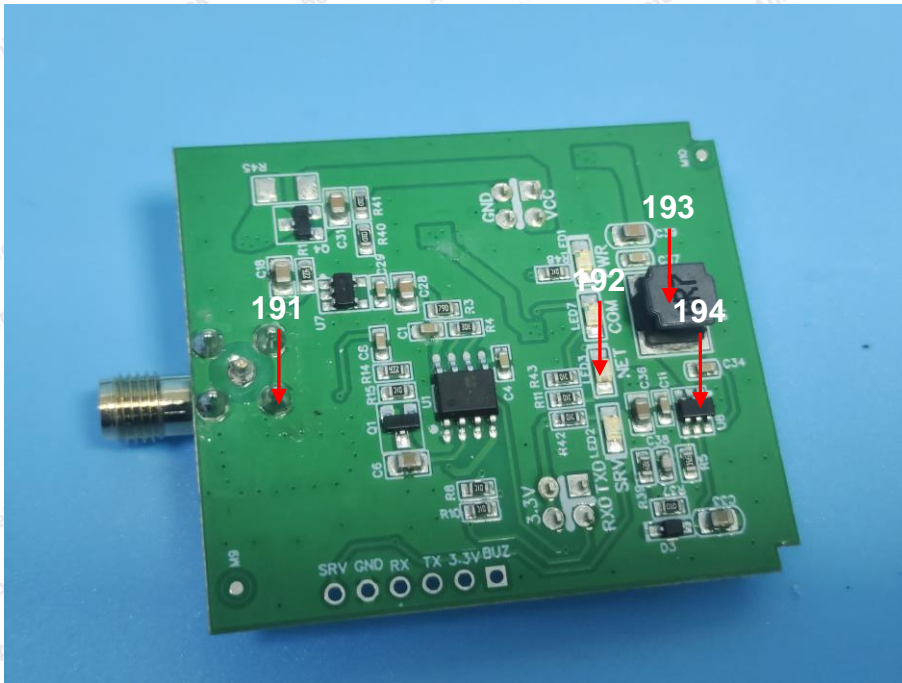
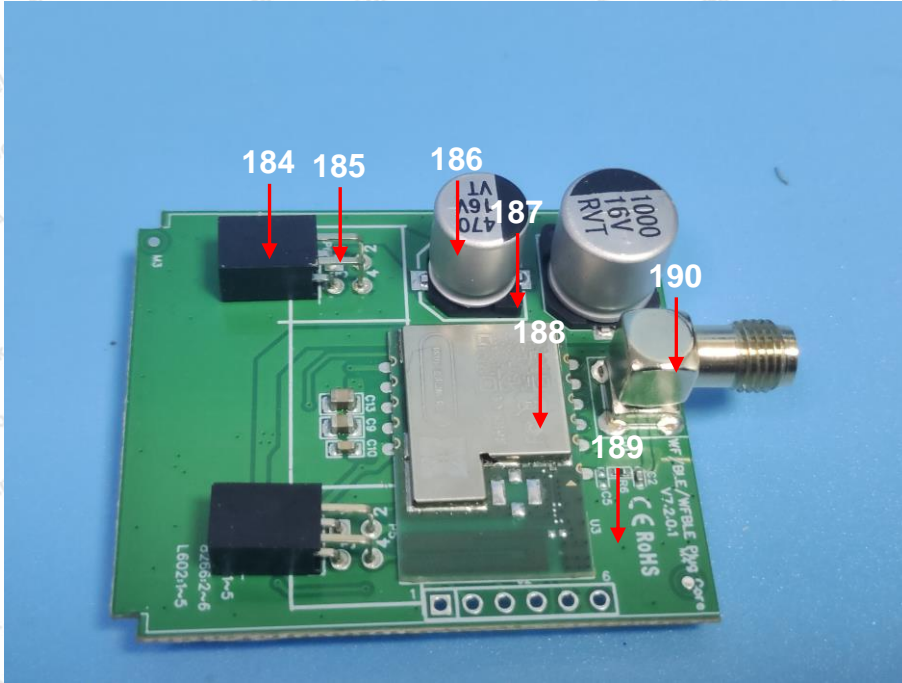

Test Report

Report No.: 18360RC40003801

Page 125 of 135

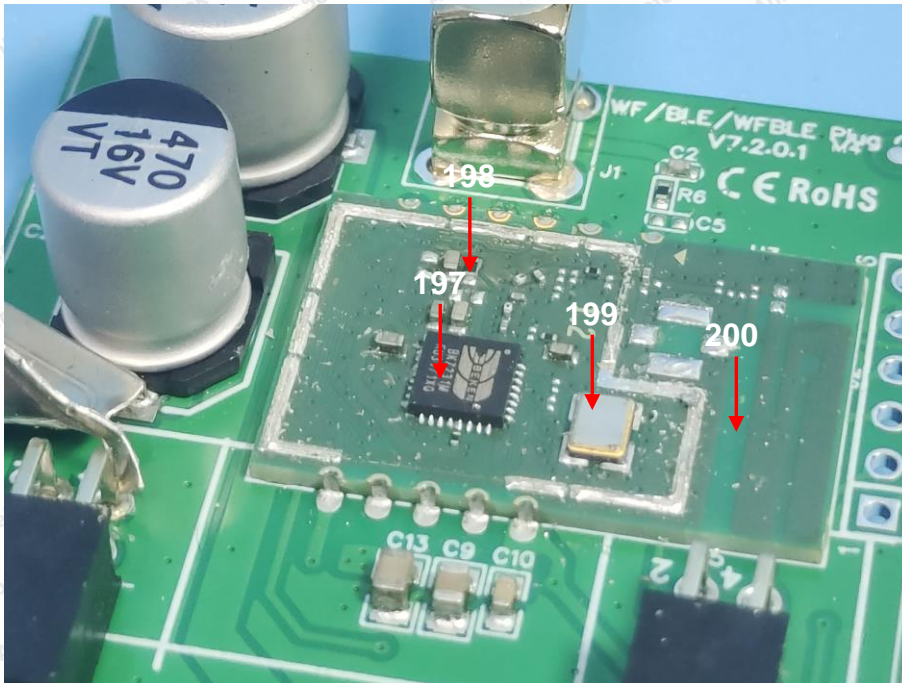
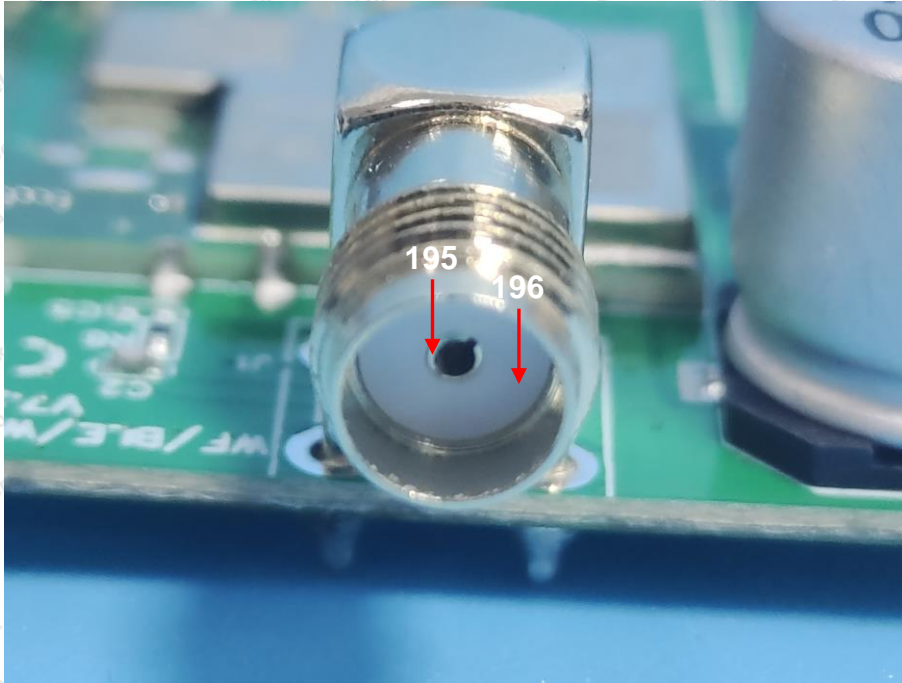

Test Report

Report No.: 18360RC40003801

Page 126 of 135

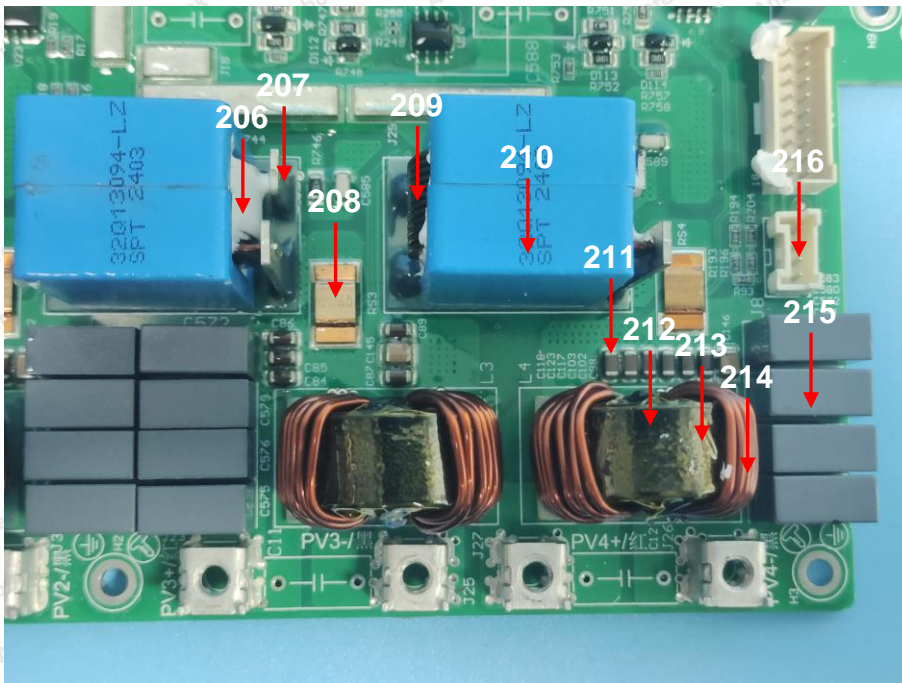
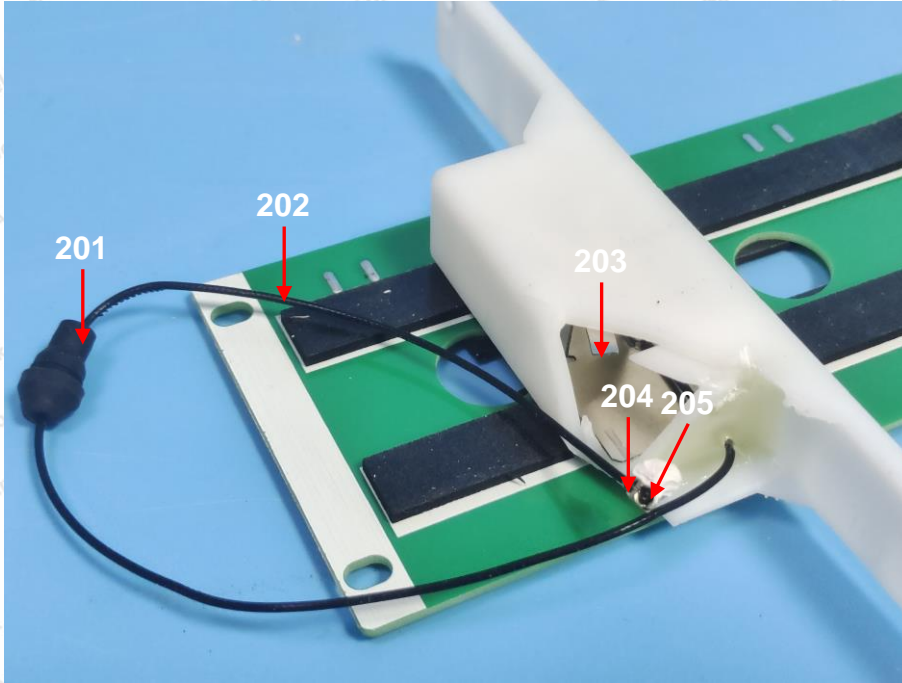

Test Report

Report No.: 18360RC40003801

Page 127 of 135

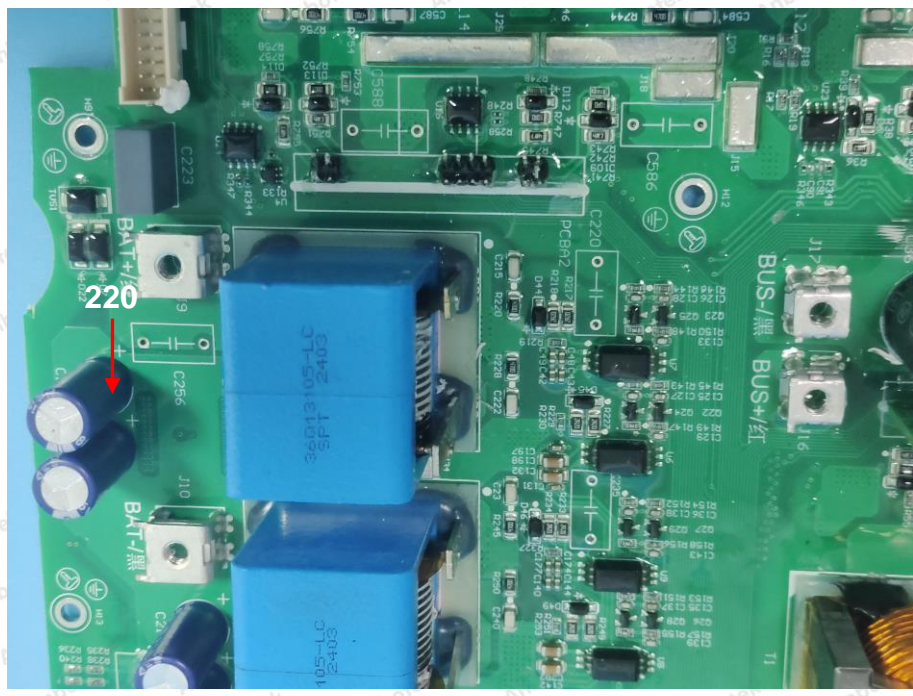
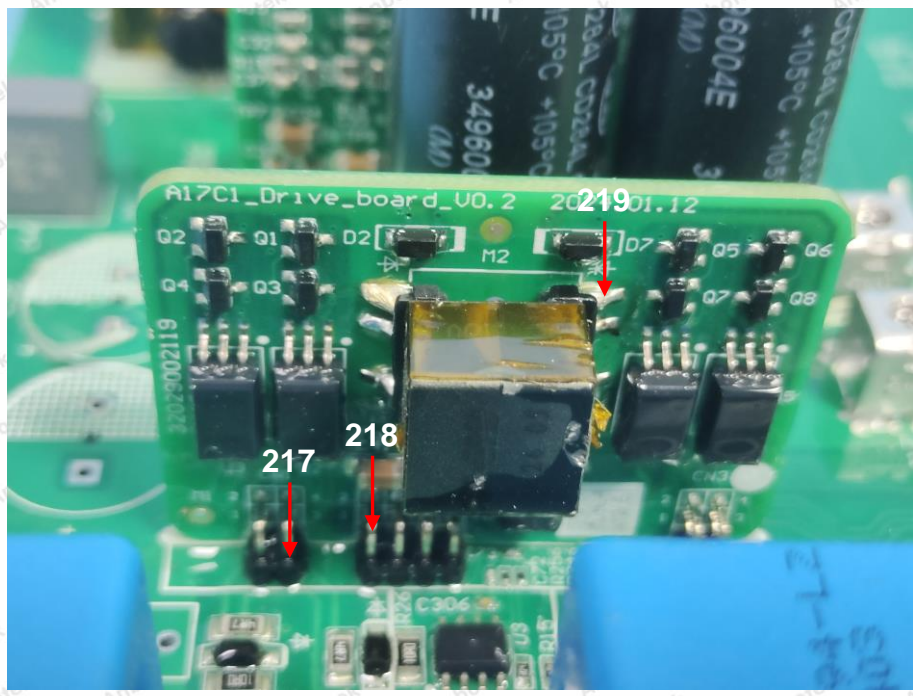

Test Report

Report No.: 18360RC40003801

Page 128 of 135

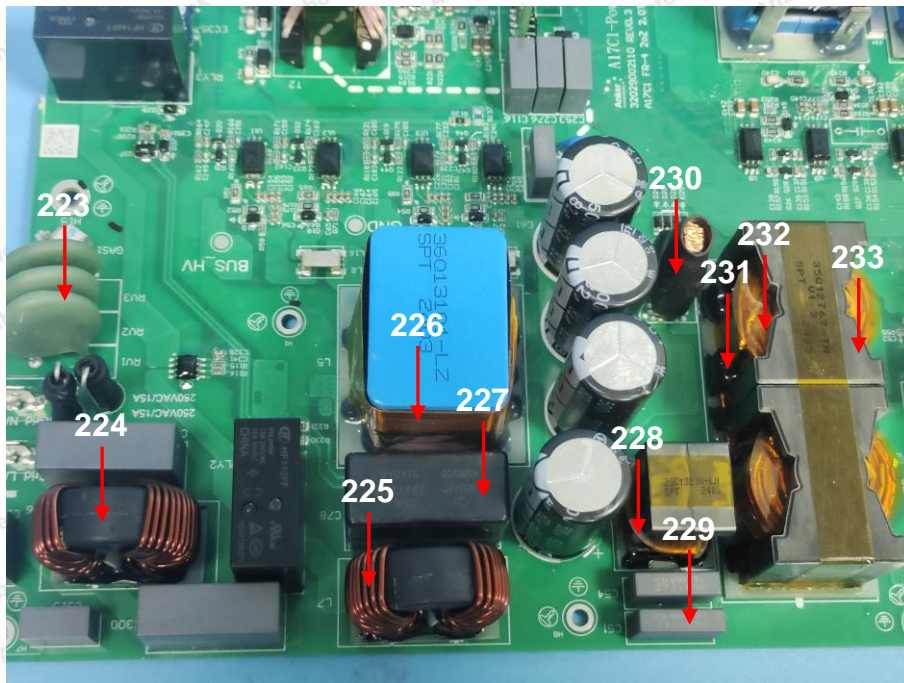
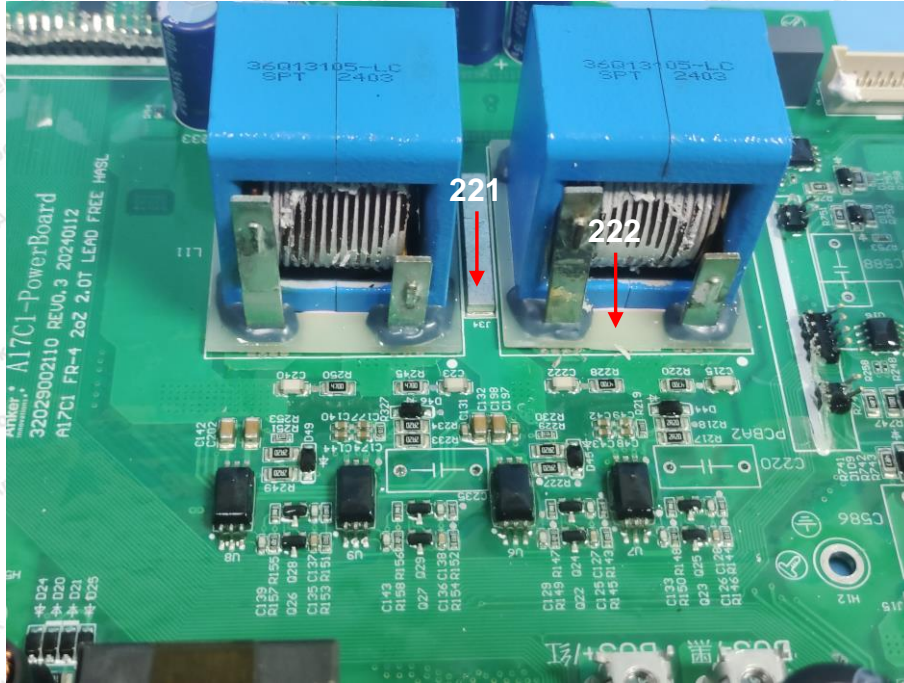

Test Report

Report No.: 18360RC40003801

Page 129 of 135

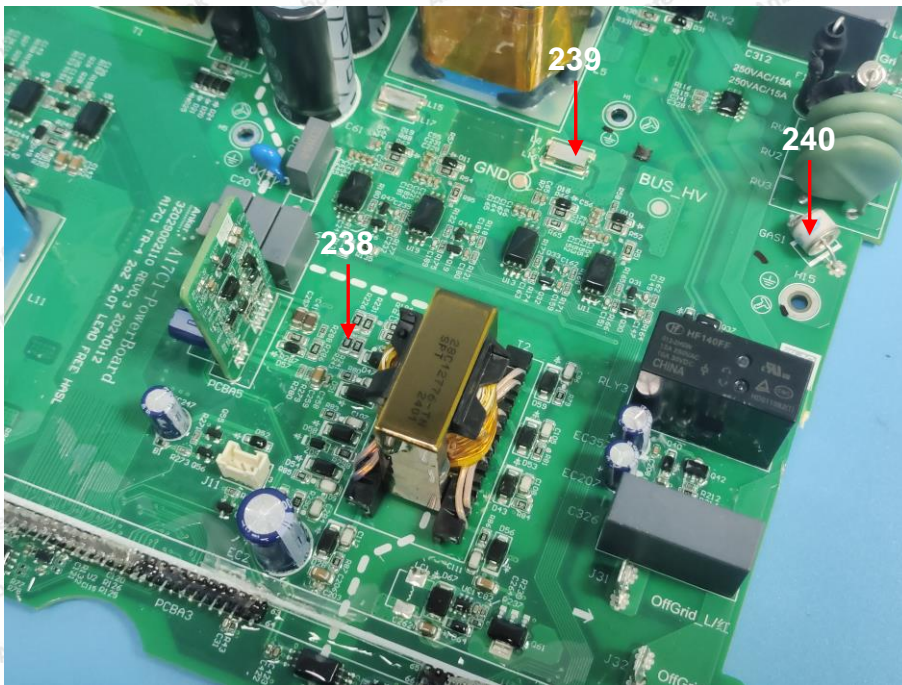
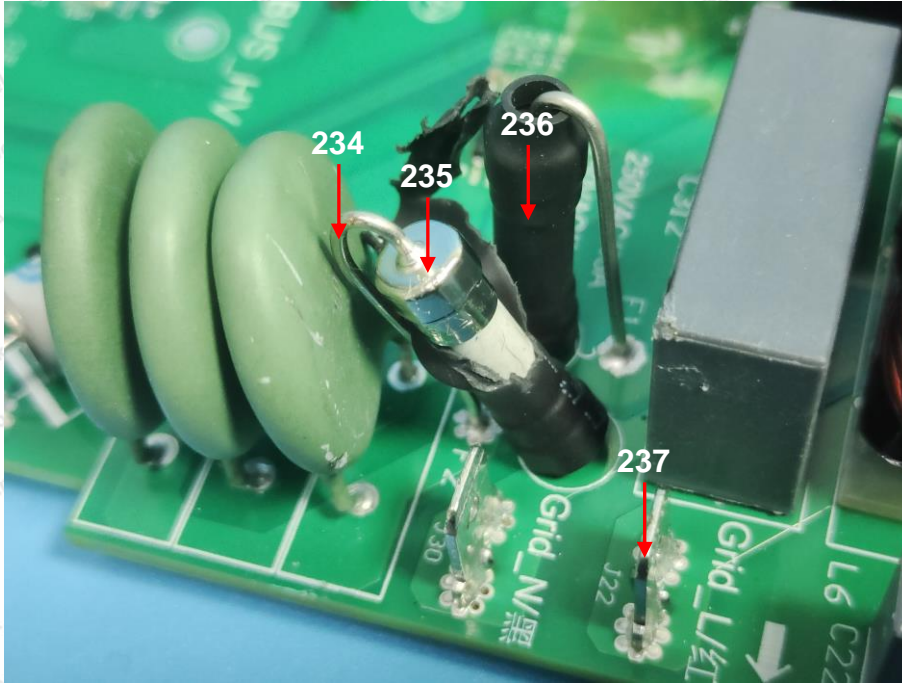

Test Report

Report No.: 18360RC40003801

Page 130 of 135

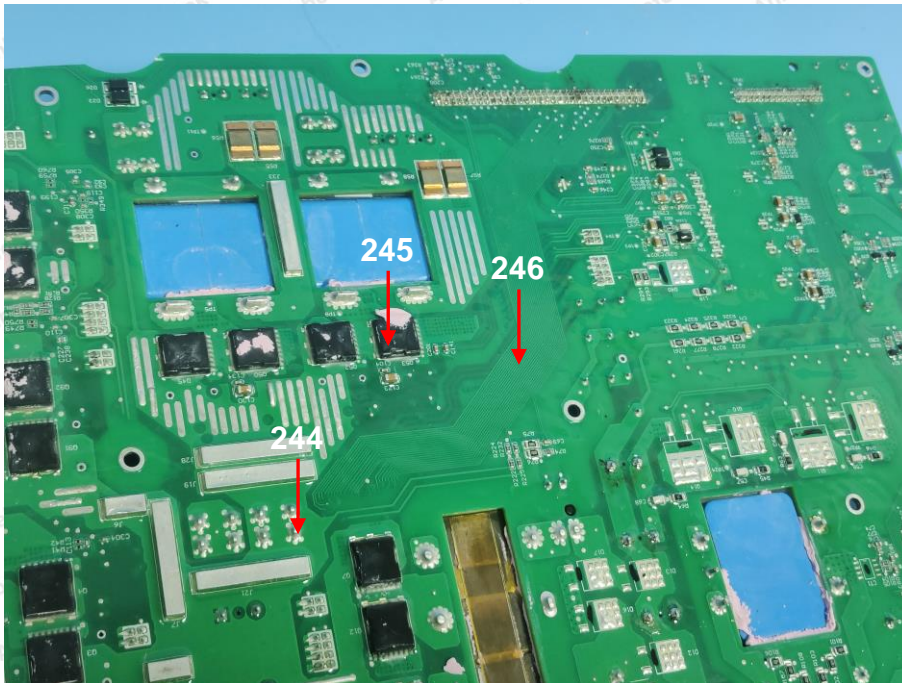
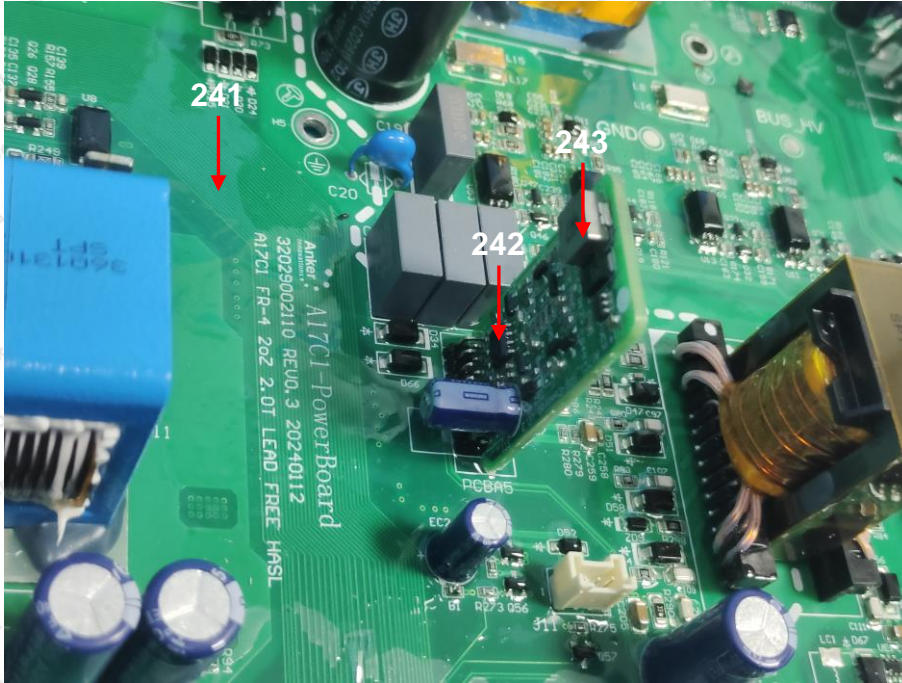

Test Report

Report No.: 18360RC40003801

Page 131 of 135

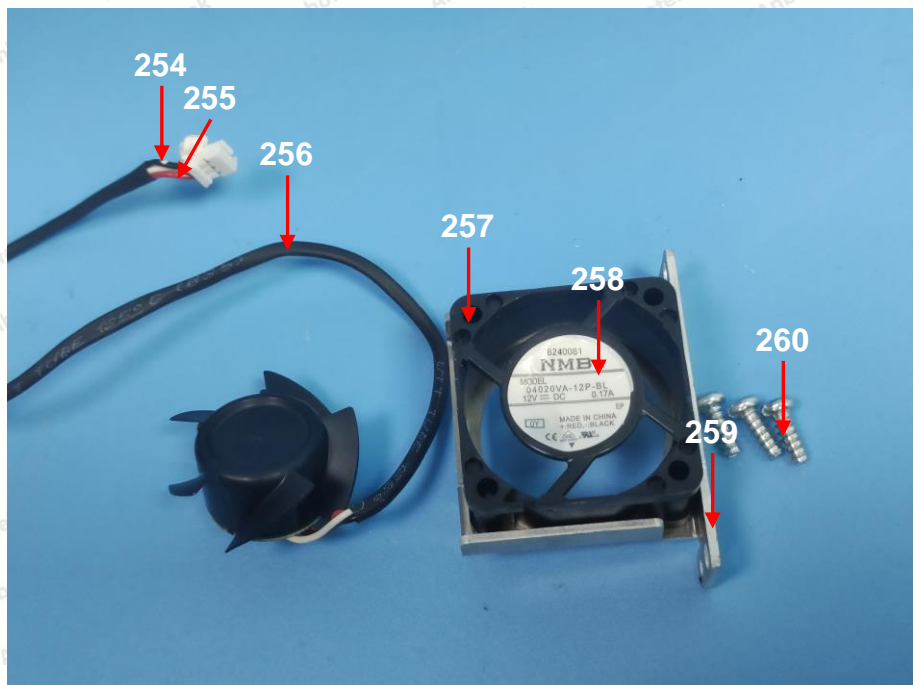

Test Report

Report No.: 18360RC40003801

Page 132 of 135

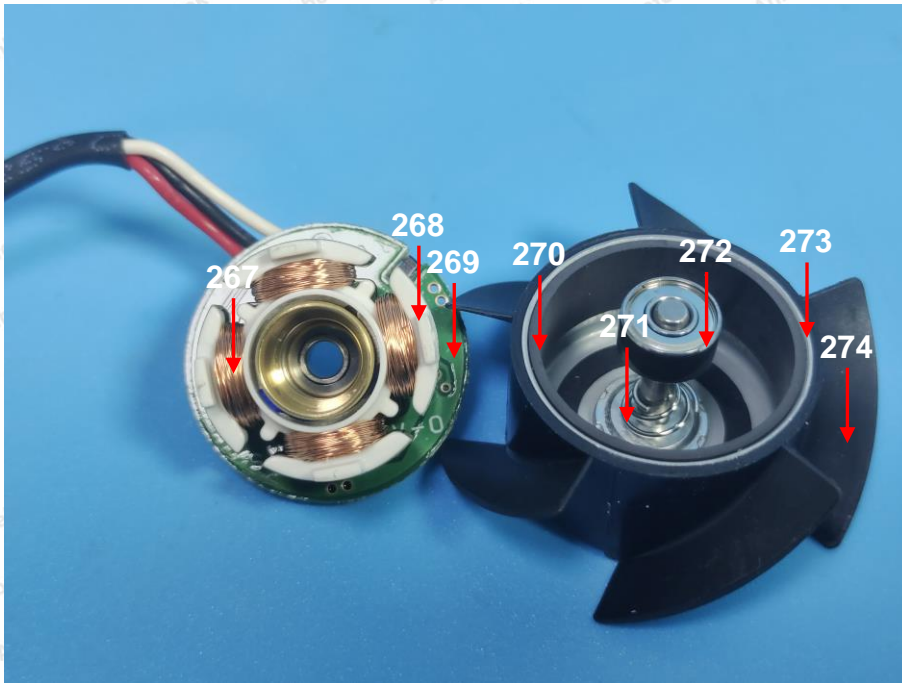
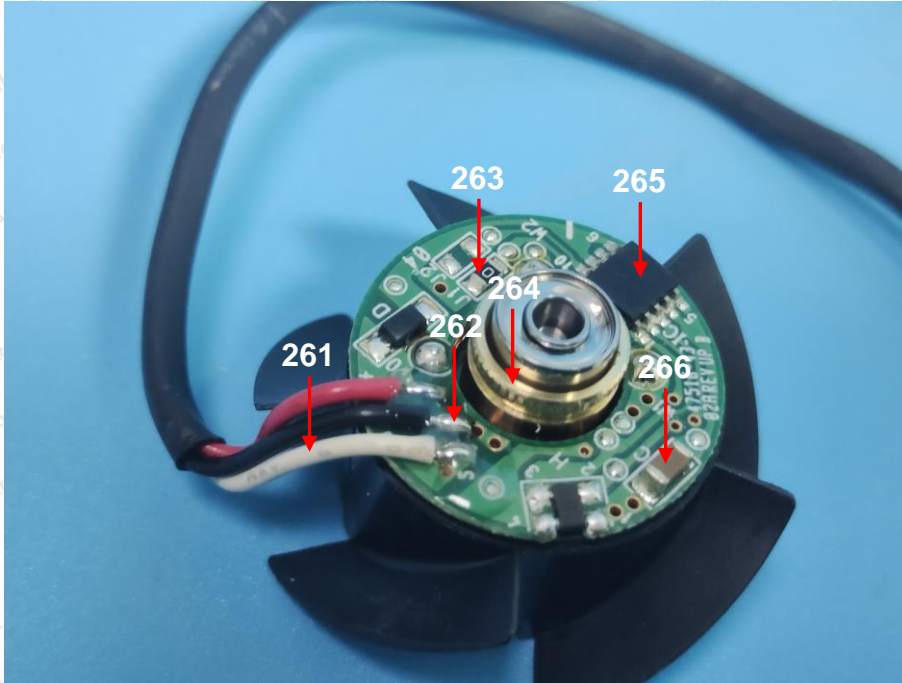

Test Report

Report No.: 18360RC40003801

Page 133 of 135

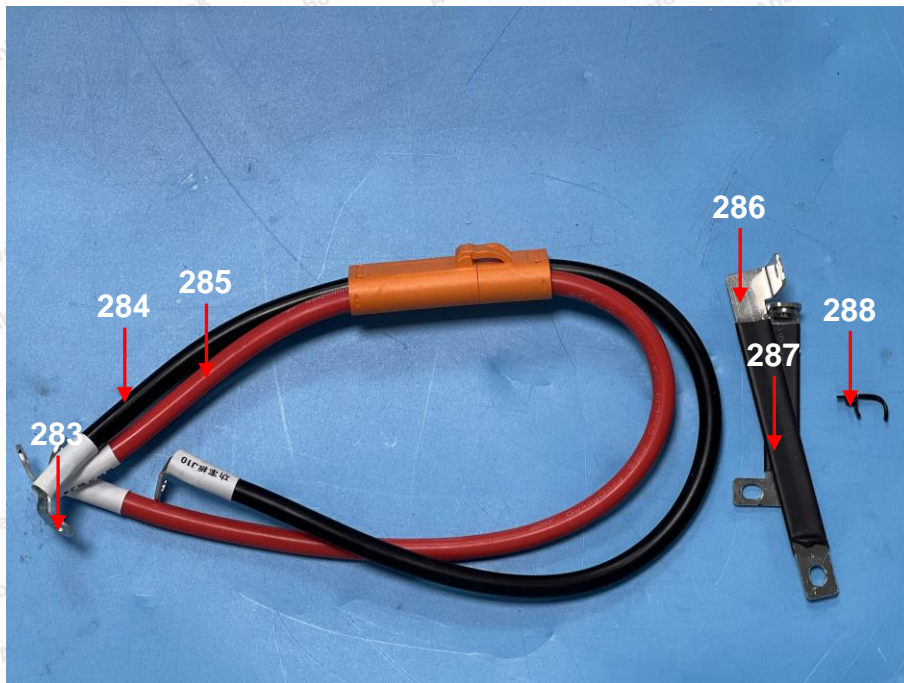
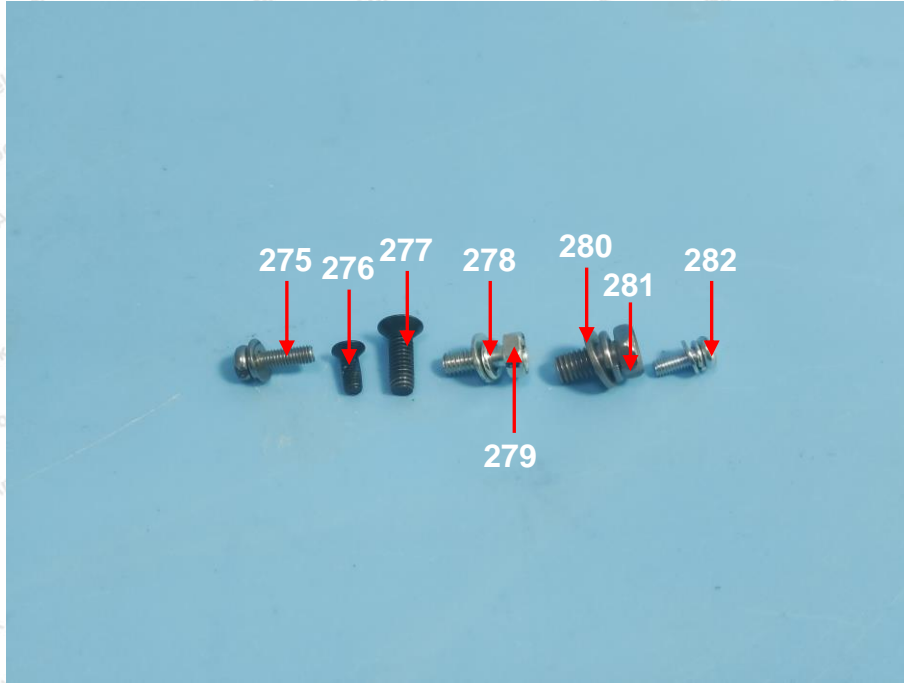

Test Report

Report No.: 18360RC40003801

Page 134 of 135

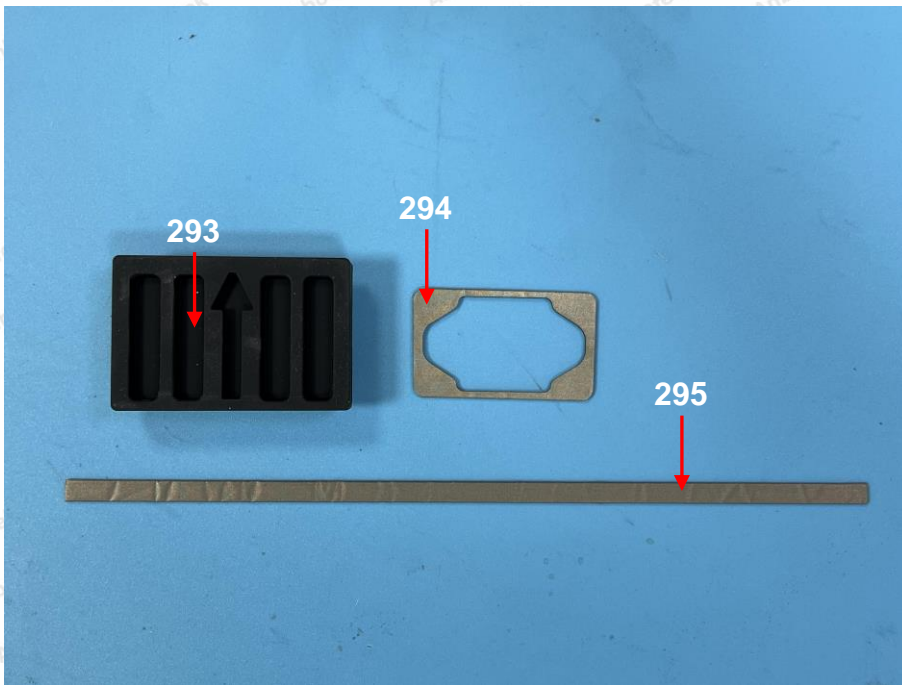
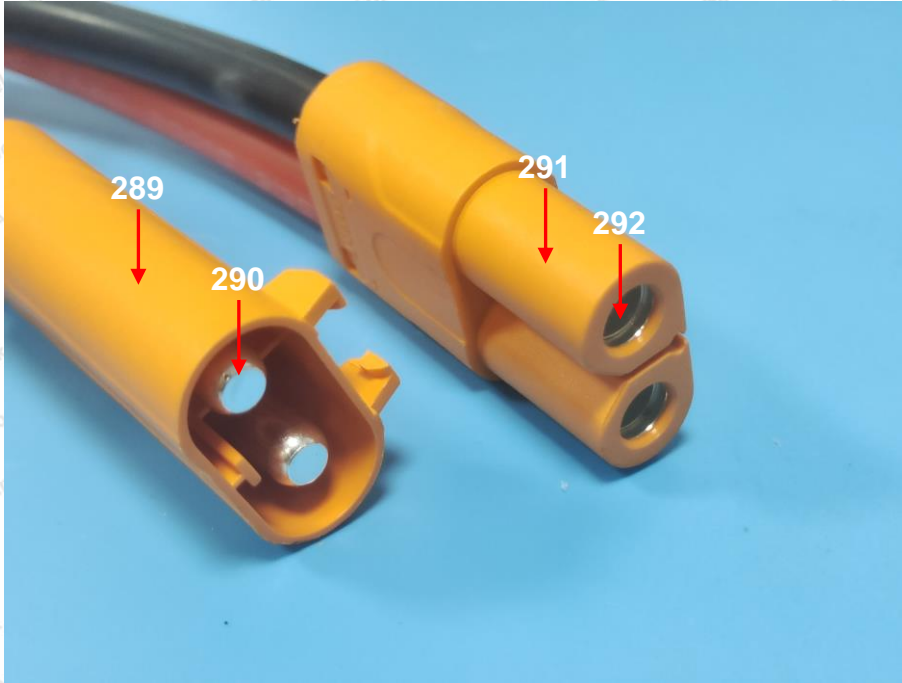

Test Report

Report No.: 18360RC40003801

Page 135 of 135

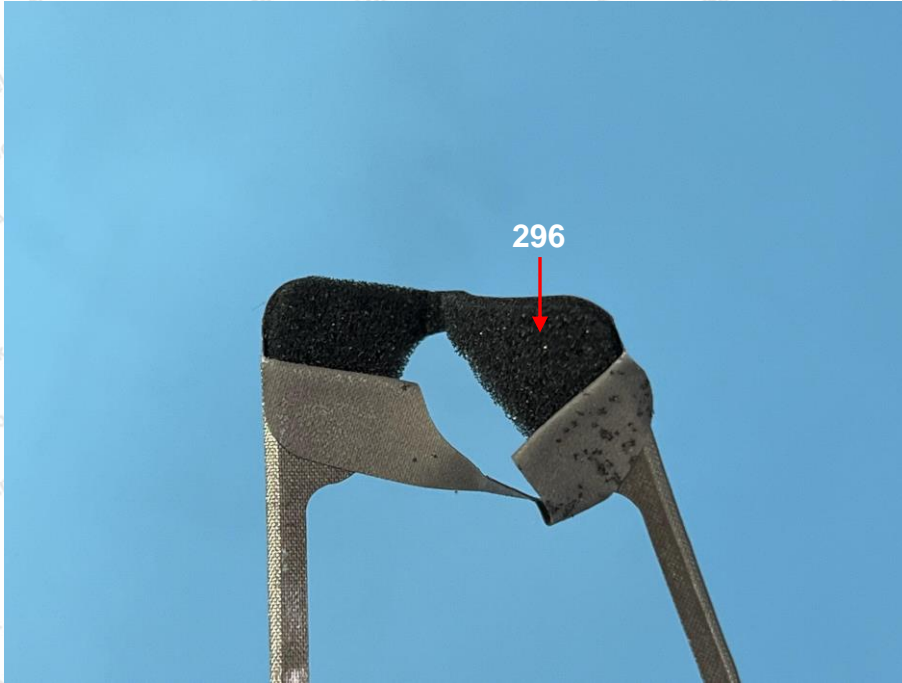

**** End of Report ****

The test report is effective only with both signature and specialized stamp. The result(s) shown in this report refer only to the sample(s) tested. Without written approval of Anbotek, this report can't be reproduced except in full.

